

PRODUCT INFORMATION PACKET



Model No: CI4D34FT5B

Catalog No: 108456.00

...75KW-1HP..3000RPM.80.IP54.24V...S1.40C.1,0SF.SPECIAL.CI4D34FT5B.....

Metric Motors



Regal and Leeson are trademarks of Regal Beloit Corporation or one of its affiliated companies.

©2018 Regal Beloit Corporation, All Rights Reserved. MC017097E





Nameplate Specifications

Output KW	0.75 kW	Voltage	24 V
Current	40.0 A	Speed	3000 rpm
Service Factor	1	Efficiency	77.4 %
Duty	S1	Insulation Class	F
Frame	80	Enclosure	IP54
Overload Protector	No	Ambient Temperature	40 °C
Drive End Bearing Size	6204	Opp Drive End Bearing Size	6203
UL	Recognized	CSA	Y
CE	N		

Technical Specifications

Rotation	Reversible	Mounting	Special
Overall Length	13.65 in	Frame Length	5.97 in
Shaft Diameter	0.750 in	Shaft Extension	2.05 in
Outline Drawing	031910-108456		

This is an uncontrolled document once printed or downloaded and is subject to change without notice. Date Created: 10/15/2018

RBC PROPRIETARY AND CONFIDENTIAL INFORMATION
 This document is the property of REGAL BELOIT CORPORATION ("RBC") including its subsidiaries and divisions and contains proprietary information of RBC. This document is loaned on the express condition that neither the information contained therein shall be disclosed to others without the express written consent of RBC, and that the information shall be used by the recipient only as approved expressly by RBC. This document shall be returned to RBC upon its request. This document may be subject to certain restrictions under U.S. export control laws and regulations.

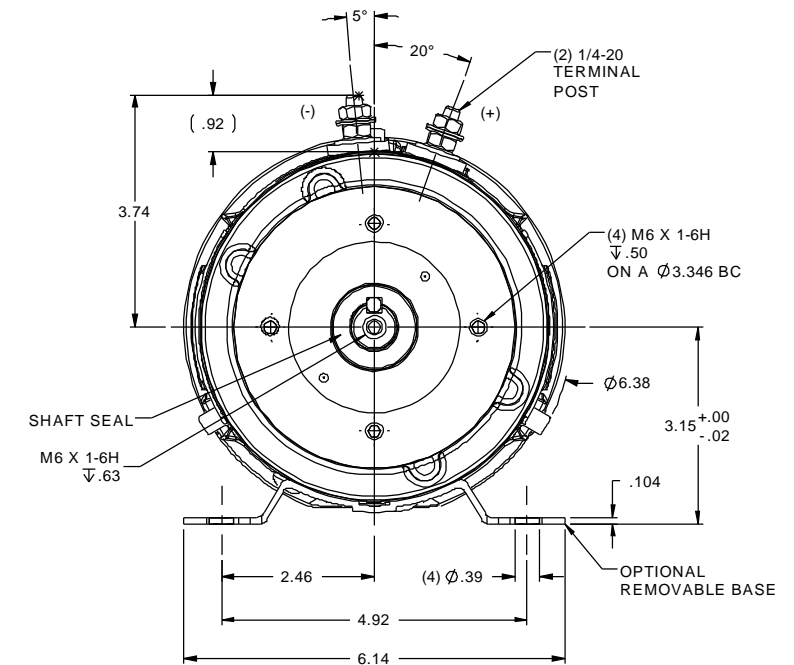
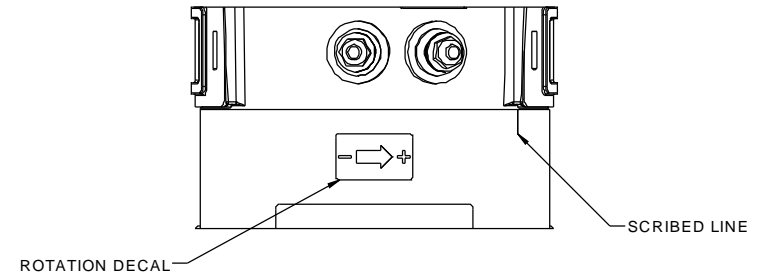
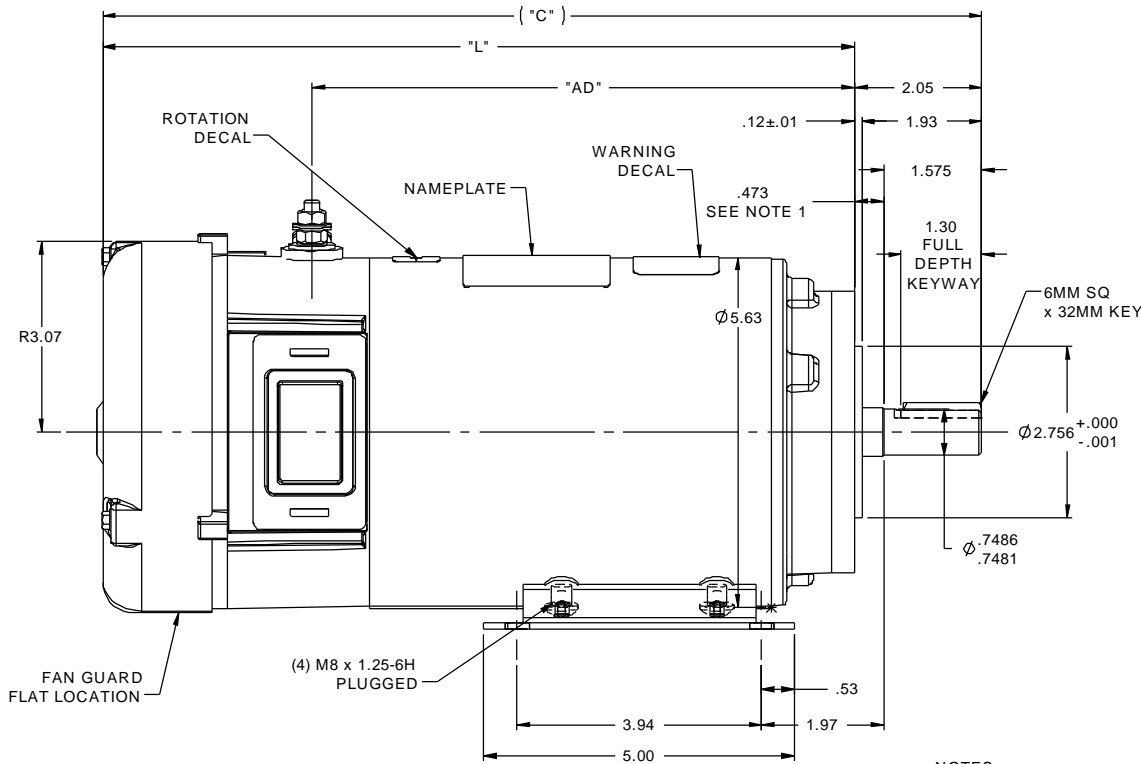

- NOTES:
 1) DIMENSION IS SPACE PROVIDED FOR A BOLT-ON B5 OR B14 ADAPTER KIT FOR THE IEC 80 FRAME.
 2) MAXIMUM FACE RUNOUT TO BE .004 T.I.R.
 3) MAXIMUM PILOT ECCENTRICITY .004 T.I.R.
 4) PERMISSIBLE SHAFT RUNOUT .002 T.I.R.
 5) GASKETS THROUGHOUT.

108456.00	13.65	11.60	8.24	24	.75	3000
108455.00	14.15	12.10	8.74	24	.75	1800
CATALOG No.	"C"	"L"	"AD"	VOLTS	K.W.	RPM

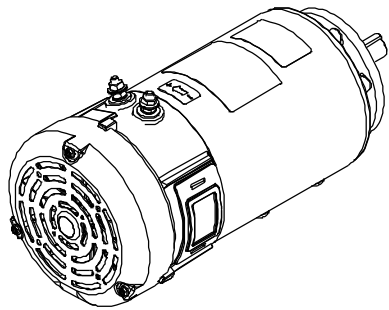

			TOLERANCES UNLESS SPECIFIED		LEESON ELECTRIC MOTORS GEARMOTORS AND DRIVES		DRAWN IPG 1/28/09	
			DEC	INCHES			CHK SK 1/28/09	APPR
01	ADDED NOTE ABOUT FAN GUARD FLAT LOCATION, ISAAC	IPG 12/10/2009	XX	±.03	TITLE OUTLINE		SCALE 1:2	
	09-4813		XXX	±.005	48 FRAME DC - IEC 80		REF 031065	
	RELEASED: REF. 031065 & 031898	IPG 1/28/2009	SK	XXXX ±.0005	MAT'L		FMF 108455.75	
NO	REVISION	BY & DATE	CHK	ANG ±1/2°	FINISH		PAGE OF	
THIRD ANGLE PROJECTION			RFP		PREV		SIZE B	DRAWING NO 031910
			NETWORK FILE NAME				REV 01	