

PRODUCT INFORMATION PACKET



Model No: C4C17FZ41C

Catalog No: 107017.00

P1100...42:1.41RPM.700LBIN..5HP.48Y...AC GEARMOTORS FHP.115/208-
230V.1PH.60HZ.TEFC.C4C17FZ41C

P1100 Series



Regal and Leeson are trademarks of Regal Beloit Corporation or one of its affiliated companies.

©2018 Regal Beloit Corporation, All Rights Reserved. MC017097E





Nameplate Specifications

Output HP	0.50 Hp	Output KW	0.37 kW
Frequency	60 Hz	Voltage	115/208-230 V
Current	8.8/4.4 A	Speed	41 rpm
Service Factor	1.15	Phase	1
Duty	Continuous	Insulation Class	F
KVA Code	K	Frame	48Y
Enclosure	Totally Enclosed Fan Cooled	Overload Protector	No
Ambient Temperature	40 °C	Drive End Bearing Size	6203
Opp Drive End Bearing Size	6203	UL	Recognized
CSA	Y	CE	N

Technical Specifications

Rotation	Reversible	Mounting	Special
Shaft Type	Parallel	Overall Length	14.17 in
Frame Length	6.25 in	Shaft Diameter	0.750 in
Shaft Extension	1.5 in		
Outline Drawing	031836-625	Connection Diagram	005005.01

This is an uncontrolled document once printed or downloaded and is subject to change without notice. Date Created: 10/15/2018

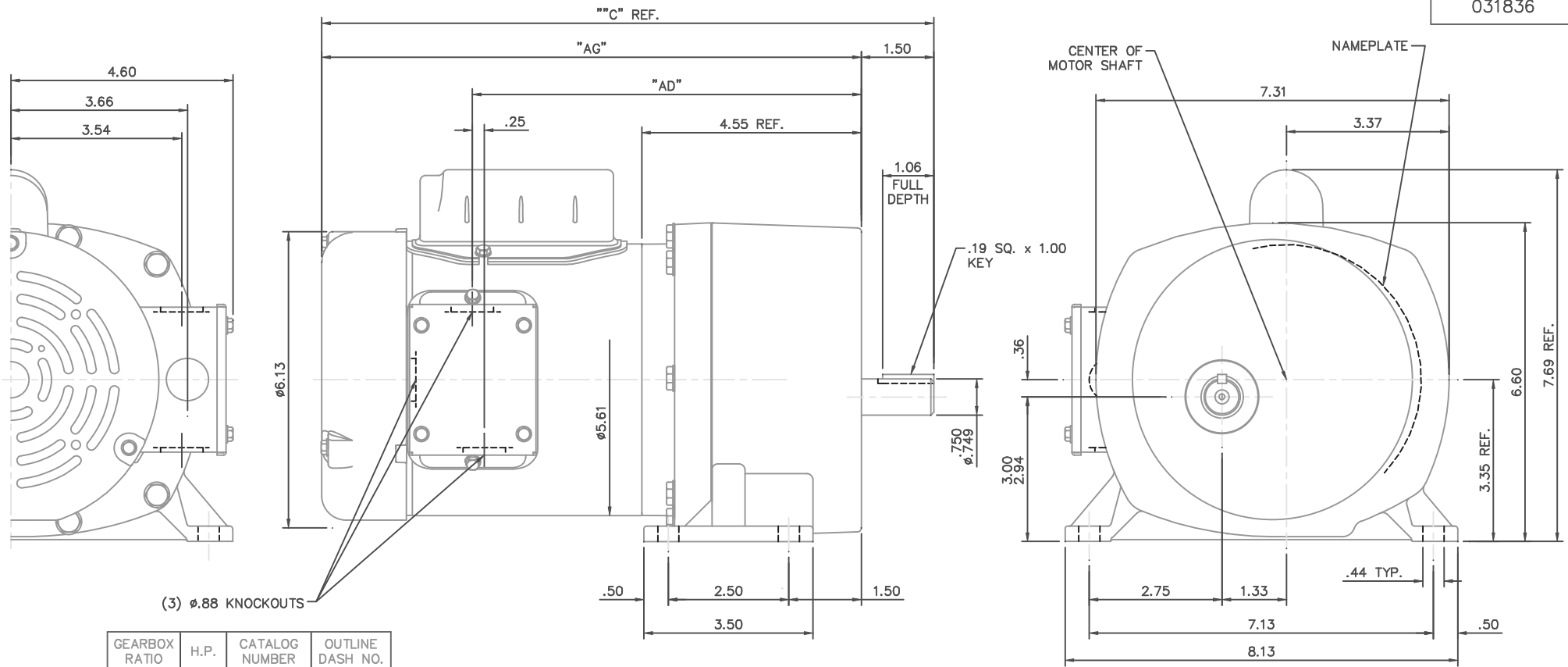

(3) ø.88 KNOCKOUTS

GEARBOX RATIO	H.P.	CATALOG NUMBER	OUTLINE DASH NO.
212:1	1/4	107000.00	550
13:1	1/4	107001.00	550
66:1	1/4	107002.00	550
95:1	1/4	107003.00	550
143:1	1/4	107004.00	550
29:1	1/4	107005.00	550
95:1	1/3	107006.00	575
6:1	1/3	107007.00	575
11:1	1/3	107008.00	575
19:1	1/3	107009.00	575
29:1	1/3	107010.00	575
42:1	1/3	107011.00	575
66:1	1/3	107012.00	575
79:1	1/2	107013.00	625
13:1	1/2	107014.00	625
19:1	1/2	107015.00	625
29:1	1/2	107016.00	625
42:1	1/2	107017.00	625

OUTLINE DASH NO.	"C"	"AG"	"AD"
550	13.42	11.92	8.81
575	13.67	12.17	9.06
625	14.17	12.67	9.56

GASKETS THROUGHOUT

NO.		REVISION	BY & DATE	CHK	ANG	±1/2"	FINISH	STANDARD	PREV
THIS DRAWING IN DESIGN AND DETAIL IS OUR PROPERTY AND MUST NOT BE USED EXCEPT IN CONNECTION WITH OUR WORK ALL RIGHTS OF DESIGN AND INVENTION ARE RESERVED THIS IS AN ELECTRONICALLY GENERATED DOCUMENT - DO NOT SCALE THIS PRINT				RFP	CAD FILE	031836	SIZE	DRAWING NO.	REV.
				DIST			B	031836	

TOLERANCES UNLESS SPECIFIED		LEESON		ELECTRIC MOTORS GEARMOTORS AND DRIVES		DRAWN PG 11/28/05	
DEC.	INCHES					CHK	
.X	±.1					APPD	
.XX	±.03	TITLE		OUTLINE - 48 FRAME TEFC GEARMOTOR		SCALE 1=2	
.XXX	±.005	MAT'L		1 PHASE		REF 031216	
.XXXX	±.0005	FINISH		STANDARD		FMF 107000.00	

VIEW FROM OUTSIDE OF MOTOR AT SWITCH END.

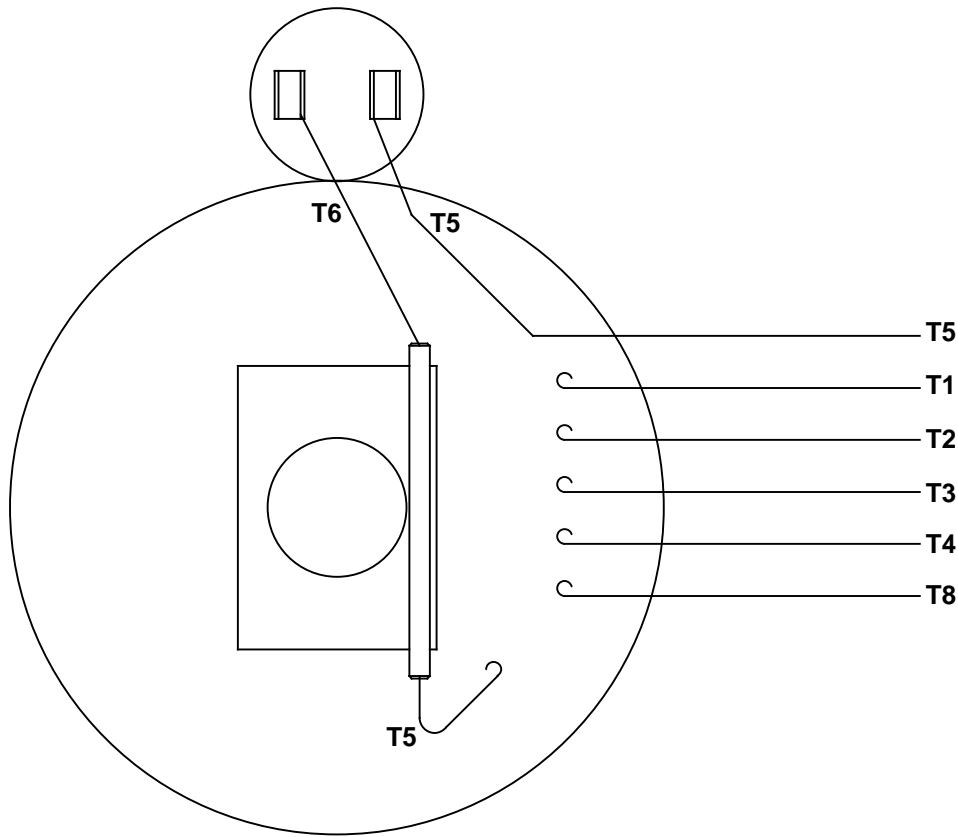

LINE LEADS



	ROTATION FACING LEAD END	L1	L2	JOIN
HIGH VOLT	C.C.W.	T1	T4, T5	T2, T3, T8
	C.W.	T1	T4, T8	T2, T3, T5
LOW VOLT	C.C.W.	T1, T3, T8	T2, T4, T5	-----
	C.W.	T1, T3, T5	T2, T4, T8	-----

RBC PROPRIETARY AND CONFIDENTIAL INFORMATION
 This document is the property of REGAL BELOIT CORPORATION ("RBC") including its subsidiaries and divisions and contains proprietary information of RBC. This document is loaned on the express condition that neither it nor the information contained therein shall be disclosed to others without the express written consent of RBC, and that the information shall be used by the recipient only as approved expressly by RBC. This document shall be returned to RBC upon its request. This document may be subject to certain restrictions under U.S. export control laws and regulations.

--	REDRAWN IN SOLIDWORKS	VJB 02/16/11		TOLERANCES UNLESS SPECIFIED			ELECTRIC MOTORS GEARMOTORS AND DRIVES	DRAWN ADH 08/06/73	
27	UPDATED TO CURRENT STANDARDS	DBT 05/27/97		DEC	INCHES			CHK	
26	ADDED PAGE 32 (114787) & PAGE 33 (114788)	KAZ 12/20/95	PG	.X	±.1			APPR JCW 03/09/79	
25	ADDED PAGE 31	KAZ 04/19/95	DL	.XX	±.01	TITLE	EXTERNAL WIRING DIAGRAM	SCALE 1:1	
24	ADDED PAGES 29 & 30	KMM 03/30/95	DL	.XXX	±.005		TYPE "C" W/O PROTECTOR	REF FIG 2-23 C4A	
23	ADDED PAGE 28	KMM 01/27/95		.XXXX	±.0005	MAT'L	DECAL - 004012	FMF MGI-2.4B	
NO	REVISION	BY & DATE	CHK	ANG	±1/2°	FINISH		PAGE OF	
THIRD ANGLE PROJECTION					RFP	PREV	SIZE	DRAWING NO	REV
					NETWORK FILE NAME	00500501	A	005005-01	--