

DATE
MAY 3, 2004
CATALOG NO.
XV0202C

OUTLINE DIMENSIONS
3-PHASE INDUCTION MOTOR

MOTOR TYPE:
AEUHXF
FRAME NO. 256TC

Pole	HP	KW	Hz	VOLT	Syn. Speed RPM
2	20	15	60	230/460	3600

Ins	Rating	Dimension in	Approx Weight	Bearings	
F	CONT.	inches	407 lbs.	DE: 6309ZZ	NDE: 6307ZZ

Totally Enclosed Fan-Cooled Type, Squirrel-Cage Rotor.

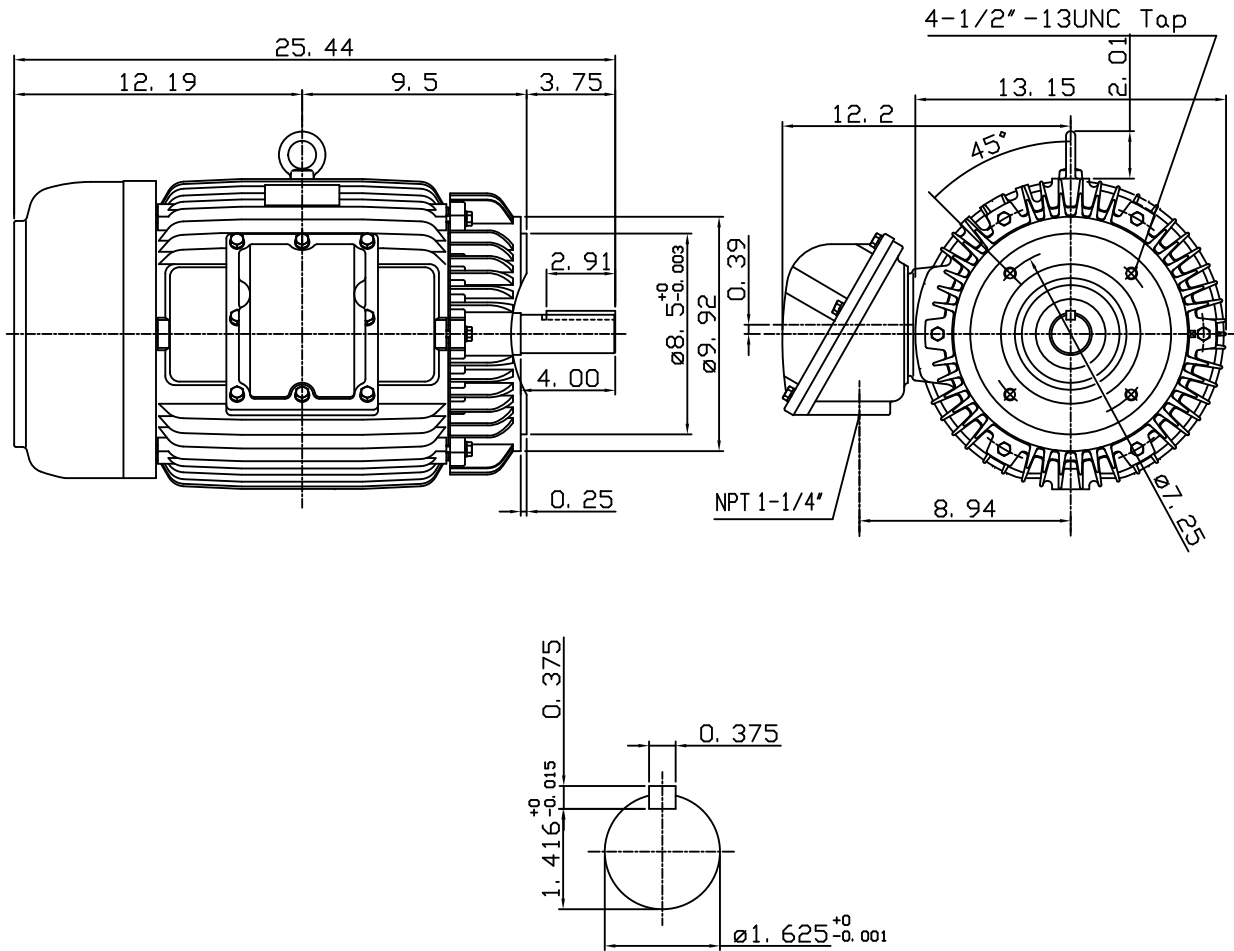

NOTE:

- EXPLOSION PROOF:
CLASS I GROUP D AND
CLASS II GROUP E, F, G.



DWN.	J. H. LIANG	12-04-98
CHKD.	C. S. LO	12-10-98
APPD.	Y. B. HUANG	12-10-98

TECO Westinghouse

DWG NO.
31049U556001