

DATE  
February 18, 2004  
CATALOG NO.  
DJP0026

OUTLINE DIMENSIONS  
3-PHASE INDUCTION MOTOR

MOTOR TYPE:  
ASGAJP  
FRAME NO. 184JP

Pole	HP	kW	Hz	VOLT	Syn. Speed r/min(rpm)
6	2	1.5	60	230/460	1200

Ins	Rating	Dimension in	Approx Weight	Bearings
F	CONT.	inches	93 lbs.	DE: 6207ZZC3 NDE: 6205ZZC3

Open Protected Drip-Proof Squirrel Cage Rotor.

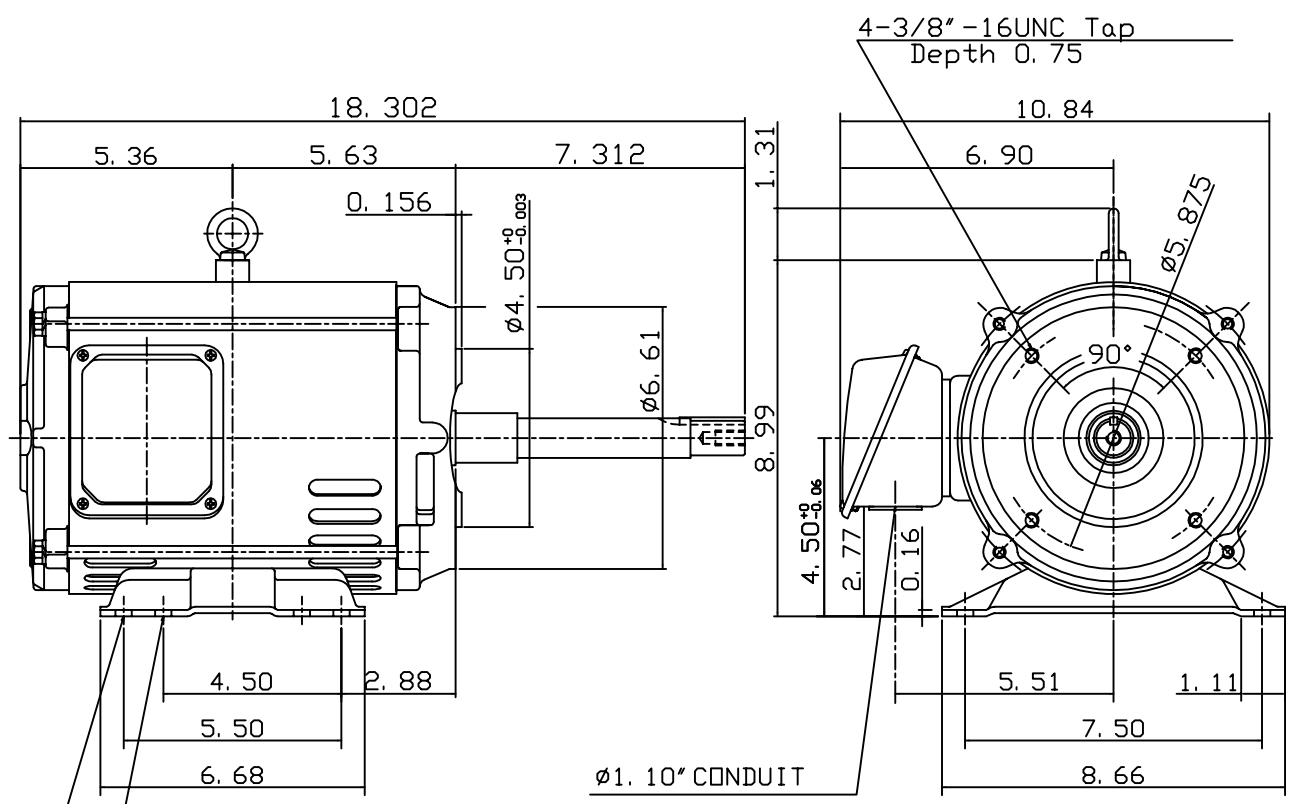

4- $\phi$ 0.41 Holes  
(182JP)  
4- $\phi$ 0.41 Holes  
(184JP)

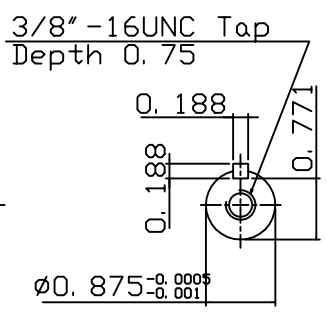
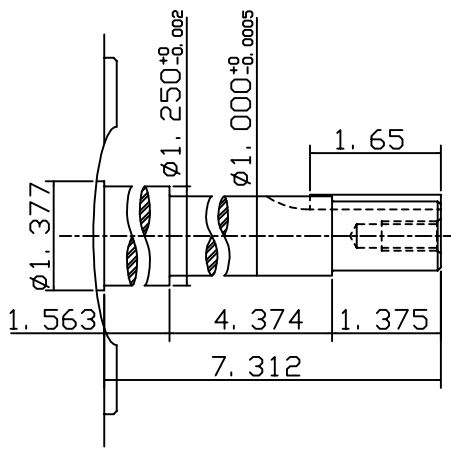

DWN.	J. T. HWANG	04-11-03
CHKD.	J. S. JEAN	04-11-03
APPD.	Y. B. HUANG	04-11-03



DWG NO.  
31049U536525