

DATE
February 18, 2004
CATALOG NO.
DJM0204

OUTLINE DIMENSIONS
3-PHASE INDUCTION MOTOR

MOTOR TYPE:
ASGAJM
FRAME NO. 256JM

Pole	HP	kW	Hz	VOLT	Syn. Speed r/min(rpm)
4	20	15	60	230/460	1800

Ins	Rating	Dimension in	Approx Weight	Bearings
F	CONT.	inches	240 lbs.	DE: 6309ZZC3 NDE: 6208ZZC3

Open Protected Drip-Proof Squirrel-Cage Rotor.

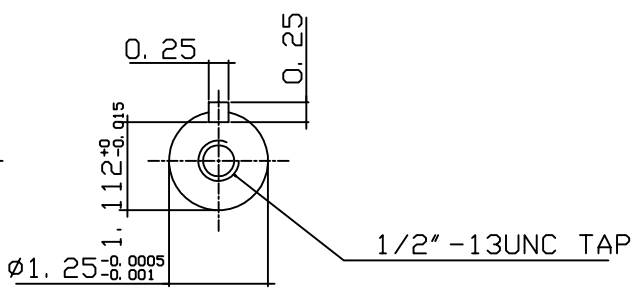
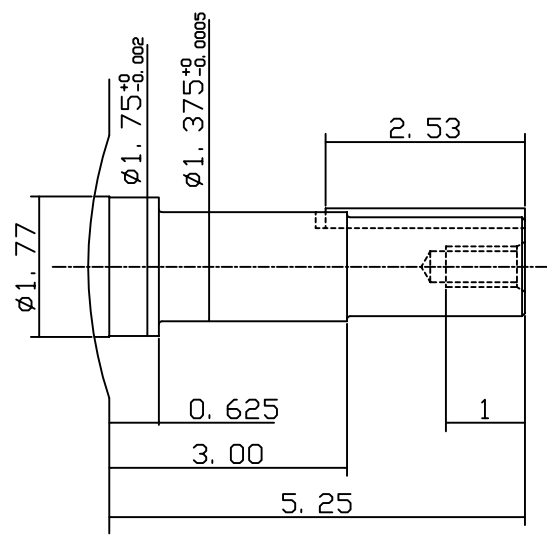
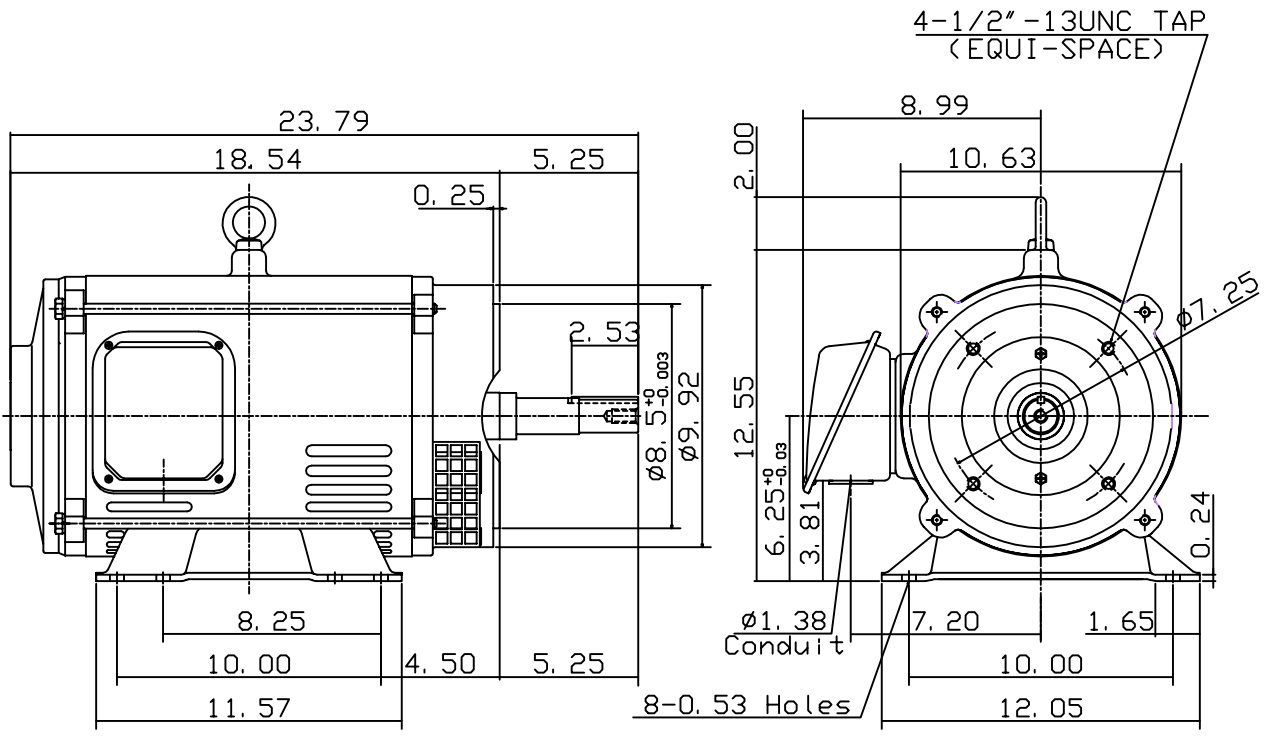

DWN.	J. T. HWANG	04-11-03
CHKD.	J. S. JEAN	04-11-03
APPD.	Y. B. HUANG	04-11-03



DWG NO.
31049U528534