



# ***AF-300 Mini***<sup>™</sup>

---

## **Startup Guide**

© 2003 GE Fuji Drives USA.

All rights reserved.

*These instructions do not purport to cover all details or variations in equipment, nor to provide for every possible contingency to be met during installation, operation, and maintenance. The information is supplied for informational purposes only, and GE Fuji makes no warranty as to the accuracy of the information included herein. Changes, modifications and/or improvements to equipment and specifications are made periodically and these changes may or may not be reflected herein. It is understood that GE Fuji may make changes, modifications, or improvements to the equipment referenced herein or to the document itself at any time. This document is intended for trained personnel familiar with the GE Fuji products referenced herein.*

*GE Fuji may have patents or pending patent applications covering subject matter in this document. The furnishing of this document does not provide any license whatsoever to any of these patents. All license inquiries should be directed to the address below. If further information is desired, or if particular problems arise that are not covered sufficiently for the purchaser's purpose, the matter should be referred to:*

*GE Fuji Drives USA*

*Post Sales Service*

*1501 Roanoke Blvd.*

*Salem, VA 24153-6492 USA*

*Phone: + 1 888 GE4 SERV (888 434 7378, United States)*

*+ 1 540 378 3280 (International)*

*Fax: + 1 540 387 8606 (All)*

*("+" indicates the international access code required when calling from outside the USA)*

*This document contains proprietary information of GE Fuji Drives USA and is furnished to its customer solely to assist that customer in the installation, testing, operation, and/or maintenance of the equipment described. This document shall not be reproduced in whole or in part nor shall its contents be disclosed to any third party without the written approval of GE Fuji Drives.*

**GE FUJI PROVIDES THE FOLLOWING DOCUMENT AND THE INFORMATION INCLUDED THEREIN AS IS AND WITHOUT WARRANTY OF ANY KIND, EXPRESS OR IMPLIED, INCLUDING BUT NOT LIMITED TO ANY IMPLIED STATUTORY WARRANTY OF MERCHANTABILITY OR FITNESS FOR PARTICULAR PURPOSE.**

AF-300Mini is a trademark of GE Fuji Drives USA, Inc.

# Contents

## Preface

Safety Precautions .....	ii
Conformity to UL standards and Canadian standards (cUL certification) .....	v
Conformity to the Low Voltage Directive in the EU .....	v
Precautions for Use .....	ix
How this Manual is Organized .....	xi
Model Numbering System .....	xii
Weights and Dimensions .....	xiii

## 1 Before Using the Drive

1.1 Acceptance Inspection .....	1-1
1.2 External View and Terminal Blocks .....	1-2
1.3 Transportation .....	1-2
1.4 Storage Environment .....	1-3
1.4.1 Temporary Storage .....	1-3
1.4.2 Long-term Storage .....	1-3

## 2 Mounting and Wiring the Drive

2.1 Operating Environment .....	2-1
2.2 Installing the Drive .....	2-1
2.3 Wiring .....	2-2
2.3.1 Removing the Terminal Block (TB) Covers .....	2-2
2.3.2 Terminal Arrangement and Screw Specifications .....	2-3
2.3.3 Wiring Precautions .....	2-4
2.3.4 Wiring for Main Circuit Terminals and Ground Terminals .....	2-5
2.3.5 Replacing the Main Circuit Terminal Block (TB) Cover .....	2-8
2.3.6 Wiring for Control Circuit Terminals .....	2-9
2.3.7 Switching of SINK/SOURCE (Jumper Bar) .....	2-13
2.3.8 Installing an RS485 Communications Card (Option) .....	2-13
2.3.9 Replacing the Control Circuit Terminal Block (TB) Cover .....	2-13
2.3.10 Cautions Relating to Harmonic Component, Noise, and Leakage Current .....	2-13
2.3.11 Recommended Wire Sizes .....	2-15

## 3 Operation Using the Keypad

3.1 Keys, Potentiometer, and LED on the Keypad .....	3-1
3.2 Overview of Operation Modes .....	3-2
3.2.1 Run Mode .....	3-2
3.2.2 Program Mode .....	3-3
3.2.3 Alarm Mode .....	3-4
3.3 Operation in Run Mode .....	3-5
3.4 Setting the Function Codes – “Data Setting” .....	3-9
3.5 Checking Changed Function Codes – “Data Checking” .....	3-11
3.6 Monitoring the Run Status – “Drive Monitoring” .....	3-12
3.7 Checking I/O Signal Status – “I/O Checking” .....	3-14
3.8 Reading Maintenance Information – “Maintenance Information” .....	3-16
3.9 Reading Alarm Information – “Alarm Information” .....	3-18

## 4 Running the Motor

4.1 Motor Testing .....	4-1
4.1.1 Inspection and Preparation prior to Operation .....	4-1
4.1.2 Turning on Power and Checking .....	4-1
4.1.3 Preparation Before Running the Motor for a Test – Setting Function Code Data .....	4-1
4.1.4 Test run .....	4-2
4.2 Operation .....	4-2

## 5 Function Codes

5.1 Function Code Tables .....	5-1
5.2 Overview of Function Codes .....	5-9

## 6 Troubleshooting

6.1 Before Proceeding with Troubleshooting .....	6-1
6.2 If No Alarm Code Appears on the LED Monitor .....	6-2
6.2.1 Motor is Running Abnormally .....	6-2
6.2.2 Problems with Drive Settings .....	6-6
6.3 If an Alarm Code Appears on the LED Monitor .....	6-7

## 7 Maintenance and Inspection

7.1 Daily Inspection .....	7-1
7.2 Periodic Inspection .....	7-1
7.3 Measurement of Electrical Values in Main Circuit .....	7-4
7.4 Insulation Test .....	7-5
7.5 List of Periodical Replacement Parts .....	7-5
7.6 Inquiries about Product and Warranty .....	7-6

## 8 Specifications

8.1 Standard Models .....	8-1
8.2 Common Specifications .....	8-6
8.3 Terminal Specifications .....	8-9
8.3.1 Terminal Functions .....	8-9
8.3.2 Connection Diagram for Operation by External Signal Inputs .....	8-9
8.4 External Dimensions .....	8-10
8.5 Protective Functions .....	8-14

## 9 Options

9.1 List Of Peripheral Equipment and Options .....	9-1
--	-----

## 10 Compliance with Standards

10.1 Compliance with UL Standard and Canadian Standards (cUL Certification) .....	10-1
10.2 Compliance with European Standard .....	10-1
10.3 Compliance with EMC Standards .....	10-1
10.4 Harmonics Component Regulation in the EU .....	10-2
10.5 Compliance with the Low Voltage Directive in the EU .....	10-3

## **Preface**

Thank you for purchasing an AF-300 Mini series drive.

This product is designed to control a 3-phase induction motor only. Read through this instruction manual and make yourself familiar with proper use of the drive.

Improper use could prevent normal operation and result in failure or reduced life of the drive.

Deliver this manual to the end user of the product. Keep this manual in a safe place until the drive is no longer in service.

## **Safety precautions**

---

Read this manual thoroughly before proceeding with installation, connecting or wiring, operation, or maintenance and inspection. Ensure you have sound knowledge of the device and familiarize yourself with all safety information and precautions before proceeding to operate the drive.

Safety precautions are classified into the following two categories in this manual.

### **WARNING**

Failure to heed the information indicated by this symbol may lead to dangerous operation, and could result in risk of death or serious bodily injury.

### **CAUTION**

Failure to heed the information indicated by this symbol may lead to dangerous operation, and could result in minor bodily injuries and/or substantial property damage.

Failure to heed the information contained under the CAUTION title can also result in serious consequences. These safety precautions are of utmost importance and must be observed at all times.

## **Purposes**

---

### **WARNING**

- The AF-300 Mini is designed to drive a 3-phase induction motor only. Never use it for 1-phase motors or for any other purpose.  
**Fire or an accident could occur.**
- The AF-300 Mini must not be used for any life-support system or other purpose directly related to human safety.

- Although the AF-300 Mini is manufactured under strict quality control, be sure to install appropriate safety devices for applications where drive failure could result in serious accident or material loss.

**An accident could occur.**

## **Installation**

---

### **WARNING**

- Install the drive on a nonflammable material base such as metal.

**Otherwise fire could occur.**

- Do not place flammable matter nearby.

**Doing so could cause fire.**

### **CAUTION**

- Do not support the drive by its cover during transportation.

**The cover could detach, allowing the drive to drop, with risk of injury.**

- Prevent lint, paper fibers, sawdust, dust, metallic chips, or other foreign materials from getting into the drive, or from accumulating on the heat sink.

**Doing so could cause fire or an accident.**

- Do not install or operate a drive that is damaged or missing any parts. Doing so could cause fire, accident or injuries.
- Do not stand or sit on a shipping box.
- Do not stack shipping boxes higher than indicated by the information printed on those boxes.

**Doing so could cause injuries.**

## **Wiring**

---

### **WARNING**

- The drive should be wired to its power source through a recommended molded case circuit breaker (MCCB) and a ground fault circuit interrupter (GFCI). Apply protective devices of the correct current range.
- Use wiring of the specified size.

**Otherwise, fire could occur.**

## WARNING

- The drive must be securely grounded.  
**Otherwise, electric shock or fire could occur.**
- Wiring must only be performed only by a qualified electrician.
- Be sure to do all wiring after installing the drive unit.  
**Otherwise, electric shock or injuries could occur.**
- Ground the drive according to the requirements of national and local industrial safety regulations.  
**Otherwise, electric shock could occur.**
- Check that the number of phases and the rated voltage of the product agree with the number of phases and the voltage of the ac power supply.  
**Otherwise fire or an accident could occur.**
- Do not connect the ac power source cables to the drive output terminals U, V, and W.
- Do not connect a braking resistor to the dc link circuit terminals P (+) and N (-).  
**Doing so could cause fire or an accident.**
- Wire the 3-phase motor to the drive's output terminals U, V, and W, aligning phases each other.  
**Otherwise injuries could occur.**
- The drive, motor and wiring generate electric noise, which could interfere with nearby sensors or other devices. To prevent the motor from malfunctioning, take appropriate noise control measures.  
**Otherwise an accident could occur.**

## Operation

---

## WARNING

- Be sure to install the terminal cover before turning the power on. Do not remove the cover while power is applied.  
**Otherwise electric shock could occur.**
- Do not operate switches with wet hands.  
**Doing so could cause electric shock.**
- If the Retry function has been enabled, the drive may automatically restart after tripping. Make sure that any automatic restart can not result in material damage or personal injury.

- If the Stall Prevention function has been selected, the drive may operate with acceleration/deceleration times or frequencies different from those selected. The drive installation must be such that safety is ensured if this occurs.

**Otherwise an accident could occur.**

## WARNING

- The STOP key is only effective when enabled by the corresponding function setting (function code F02). For safety, a separate emergency stop switch should always be installed. If you disable the STOP key priority function and activate the (FWD) or (REV) commands, it will no longer be possible to stop the motor using the STOP key on the built-in keypad.
- If an alarm reset happens with the operation signal turned on, a sudden start will occur. Check that the operation signal is turned off in advance.  
**Otherwise an accident could occur.**
- If you enable the Auto Restart function in the restart mode after an instantaneous power failure (function code F14), the drive will automatically restart the motor when power is restored.
- If you set the function codes wrongly or without completely understanding the instruction manual and the AF-300 Mini User's Manual, the motor may operate at a torque or speed not authorized for the driven load.  
**An accident or injuries could occur.**
- Do not touch the drive terminals while power is applied to the drive, even if the drive stops.  
**Doing so could cause electric shock.**
- Do not turn the main circuit power on or off in order to start or stop the drive. Doing so could result in drive failure.
- Do not touch the heat sink or braking resistor, both of which can become very hot in operation.  
**Doing so could cause burns.**
- It is possible to set the drive to operate at speeds higher than allowed by the driven load. Check the performance of the motor and connected load before changing the setting.
- The brake function of the drive does not provide mechanical holding means.

**Injuries could occur.**

## **Maintenance and inspection and parts replacement**

---

### **WARNING**

- Turn the power off and wait for at least five minutes before starting inspection.

(Also check that the LED monitor is unlit, and verify that the dc voltage across the P (+) and N (-) terminals is lower than 25 Vdc.)

**Otherwise, electric shock could occur.**

- Maintenance, inspection, and parts replacement should be made only by qualified persons.
- Remove watches, rings and other metallic objects before starting work.
- Use insulated tools.

**Otherwise, electric shock or injuries could occur.**

### **Disposal**

---

- Treat the drive as industrial waste for disposal purposes.

**Otherwise injuries could occur.**

### **Others**

---

- Never attempt to modify the drive.

**Doing so could cause electric shock or injuries.**

### **GENERAL PRECAUTIONS**

---

For explanatory purposes, drawings in this manual may show the drive without required covers or safety shields. Be sure to replace such covers and shields and follow all safety instructions in the manual before operation.

## Conformity to the Low Voltage Directive in the EU

If installed according to the guidelines given below, drives marked with CE or TUV are considered as compliant with the Low Voltage Directive 73/23/EEC.

### CAUTION

1. The ground terminal G should always be connected to the ground. Do not use only a residual-current-operated protective device (RCD)/earth leakage circuit breaker (ELCB)\* as the sole method of electric shock protection. Be sure to use ground wires whose size is greater than power supply lines.  
\*With the exception of those exclusively designed for protection from ground faults.
2. When you use a residual-current-operated protective device (RCD)/earth leakage circuit breaker (ELCB) for protection from electric shock in direct or indirect contact power lines or nodes, be sure to use type B of RCD/ELCB at the power supply side of the electric equipment for three-phase 230/460 V power supplies. For single-phase 230 V power supplies, use type A.  
When you use no RCD/ELCB, take any other protective measure that isolates the electric equipment from other equipment on the same power supply line using double-layered or reinforced insulation or that isolates the power supply lines connected to the electric equipment using an isolated transformer.
3. The drive should be used in an environment that does not exceed pollution degree 2 requirements. If the environment conforms to pollution degree 3 or 4, install the drive in a enclosure of IP54 or higher.
4. Install the drive, ac or dc reactor, input or output filter in an enclosure with minimum degree of protection of IP2X (Top panel of enclosure shall be minimum IP4X when it can be easily accessed), to prevent anyone from touching live parts of this equipment.
5. To make a drive with no integrated EMC filter conform to the EMC directive, it is necessary to connect an external EMC filter to the drive and install them properly so that the entire equipment including the drive conforms to the EMC directive.
6. Do not connect any copper wire directly to grounding terminals. Use clamp terminals with tin or equivalent plating to connect it.
7. When you use a drive at an altitude of more than 2000 m, you should apply basic insulation for the control circuits of the drive. The drive cannot be used at altitudes of more than 3000 m.
8. When used in the drive, a molded case circuit breaker (MCCB), residual-current-operated protective device (RCD)/earth leakage circuit breaker (ELCB) or magnetic contactor (MC) should conform to the EN or IEC standards.
9. Supplementary insulation is required for the control interface when the drive is installed in Overvoltage Category III in 230V class models and Overvoltage Category II or III in 460V class models.
10. The supply mains neutral has to be grounded for 3-phase 460V class drives.

**Conformity to the Low Voltage Directive in the EU (continued)**

**CAUTION**

9. Use wires listed in EN60204 Appendix C

Power supply voltage	Applicable motor rating (Hp)	Drive Hp	Rated current (A) of MCCB or RCD/ELCB *1		Main power circuit input [L1/R, L2/S & L3/T] [L1/L and L2/N] Grounding [G] *2 Recommended wire size (mm2)		Drive output [U, V and W] *2	DCR [P1 and P (+)] Braking resistor [P (+) and DB] *2	Control circuit
			w/ DCR	w/o DCR *3	w/ DCR	w/o DCR *3			
3-phase 230 V	1/8	1/8	6	6	2.5	2.5	2.5	2.5	0.5
	1/4	1/4		6					
	1/2	1/2		10					
	1	1	10	16					
	2	2		20					
	3	3		4					
	5	5	20	35		4			
3-phase 460 V	1/2	1/2	6	6	2.5	2.5	2.5	2.5	0.5
	1	1		10					
	2	2		16					
	3	3	10	20					
	5	5		20					
1-phase 230 V	1/8	1/8	6	6	2.5	2.5	2.5	2.5	0.5
	1/4	1/4		10					
	1/2	1/2		16					
	1	1	16	20					
	2	2	20	4					
	3	3	20	35		4			

MCCB: Molded case circuit breaker

RDC: Residual-current-operated protective device

ELCB: Earth leakage circuit breaker

\*1 The frame size and model of the MCCB or RCD/ELCB (with the exception of those exclusively designed for protection from ground faults) will vary, depending on the power transformer capacity. Refer to the related technical documentation for details.

\*2 The above wire size for main circuits is recommended for the 70° C 600V PVC wires used at an ambient temperature of 40°C.

\*3 Wire sizes are calculated on the basis of the input current under the condition that the power supply capacity and impedance are 500 kVA and 5%, respectively.



## Conformity to UL standards and Canadian standards (cUL certification) continued

If installed according to the guidelines given below, Drives marked with UL/cUL are considered as compliant with the UL and CSA (cUL certified) standards.

### CAUTION

1. Solid state motor overload protection (motor protection by electronic thermal overload relay) is provided in each model.  
Adjust function F10 to F12 decide the protection Level.
2. Connect the power supply satisfying the characteristics shown in the table below as an input power supply of the drive.(Short circuit rating)
3. Use 75° C Cu wire only.
4. Use Class 1 wire only for control circuits.
5. Field wiring connection must be made by a UL Listed and CSA Certified closed-loop terminal connector sized for the wire gauge involved. Connector must be fixed using the crimp tool specified by the connector manufacturer.

### Short circuit rating

Suitable for use on a circuit capable of delivering not more than B rms symmetrical amperes, A Volts maximum.

Power supply voltage	Drive Hp	Power supply max. voltage A	Power supply current B
3-phase 230V	1/8	240 Vac	100,000 A or less
	1/4		
	1/2		
	1		
	2		
	3		
	5		
3-phase 460V	1/2	480 Vac	100,000 A or less
	1		
	2		
	3		
	5		
1-phase 230V	1/8	240 Vac	100,000 A or less
	1/4		
	1/2		
	1		
	2		
	3		
1-phase 115V	1/8	120 Vac	65,000 A or less
	1/4		
	1/2		
	1		

Conformity to UL standards and Canadian standards (cUL certification) continued

**CAUTION**

6. Install a UL certified fuse or curciut breaker between the power supply and the drive, referring to the table below.

Power Supply Voltage	Drive Hp	Required torque lb/in (N/m)			Wire size AWG or kcmil (mm <sup>2</sup> )			Class J Fuse Current (A)		Circuit Breaker Current (A)	
		Main Terminal	Control circuit		Main Terminal *3	Control circuit		without DC Reactor	with DC Reactor	without DC Reactor	with DC Reactor
			TERM1 *1	TERM2-1 TERM2-2 *2		TERM1 *1	TERM2-1 TERM2-2 *2				
3-phase 230V	1/8	10.6 (1.2)	3.5 (0.4)	1.8 (0.2)	*4	20 (0.5)	3	3	5	5	
	1/4						6	3	5	5	
	1/2						10	3	5	5	
	1						15	6	10	5	
	2	15.9 (1.8)	3.5 (0.4)	1.8 (0.2)	*4	20 (0.5)	20	10	15	10	
	3						30	15	20	10	
	5						40	20	30	20	
3-phase 460V	1/2	15.9 (1.8)	3.5 (0.4)	1.8 (0.2)	*4	20 (0.5)	3	3	5	5	
	1						6	3	5	5	
	2						10	6	10	5	
	3						15	10	15	5	
	5	20	15	20	10						
1-phase 230V	1/8	10.6 (1.2)	3.5 (0.4)	1.8 (0.2)	*4	20 (0.5)	6	3	5	5	
	1/4						6	3	5	5	
	1/2						10	6	10	5	
	1	15.9 (1.8)	3.5 (0.4)	1.8 (0.2)	*4	20 (0.5)	15	10	15	10	
	2						30	20	20	15	
	3						40	30	30	20	
1-phase 115V	1/8	10.6 (1.2)	3.5 (0.4)	1.8 (0.2)	*4	20 (0.5)	6	6	5	5	
	1/4						10	6	10	5	
	1/2						15	10	15	10	
	1						30	20	20	15	

\*1: Denotes the relay contact terminals for 30A, 30B and 30C.

\*2: Denotes control terminals except for 30A, 30B and 30C.

\*3: Use 75° Cu wire.

\*4: See page 2-15, table 2.6 for details.

## Precautions for Use

Application with standard motors	Driving a 460V standard motor	When operating a 460 V standard motor on a drive with extremely long cables, damage to the insulation of the motor may occur. Use an output circuit filter (OFL) if necessary after checking with the motor manufacturer. GE motors do not require the use of output circuit filters because of their superior insulation.
	Torque characteristics and temperature rise	A standard motor will run hotter when operated with a drive than if connected to standard ac power. Furthermore, the effectiveness of the motor's cooling fan is reduced in the low-speed range, which in turn reduces the allowable output torque. (If constant torque is required in the low-speed range, either use a GE drive motor or a motor equipped with a separate cooling fan.)
	Vibration	Use of a drive does not increase vibration of a standard motor, but when the motor is mounted to a driven load mechanical resonances may be caused by the combined natural frequencies of the total machine system. * The use of a rubber coupling or vibration dampening rubber is recommended. * It is also recommended to use the drive Jump Frequency control function to avoid operating at resonance points. Note that operation of a 2-pole motor at 60 Hz or above may cause abnormal vibration.
	Noise	When a drive is used with a standard motor, the motor noise level will be higher than that with a commercial power supply. To reduce noise, raise carrier frequency of the drive. High-speed operation at 60 Hz or higher frequencies can also result in increased noise.
Application with special motors	Explosion-proof motors	When using an explosion-proof motor with a drive, use a only an approved drive/motor combination.
	Submersible motors and pumps	This type of motor has a higher current rating than standard motors. Select a drive capacity that will ensure that these motors run within the rated current capacity of the drive. These motors also differ from standard motors in their thermal characteristics. Set a low value in the thermal time constant of the motor when setting the electronic thermal protection.
	Motors fitted with brakes	Do not use motors with parallel-connected brakes that obtain their braking power from the primary circuit (commercial power supply). If the brake power is connected to the drive power output circuit by mistake, problems may occur. Do not use drives on motors equipped with series-connected brakes.
Using a drive with special motor types	Gearmotors	When the power transmission mechanism uses an oil-lubricated gearbox or speed changer/reducer, continuous motor operation at low speed may cause poor lubrication.
	Synchronous motors	Special software suitable for this motor type must be used. Contact GE Fuji for details.
	1-phase motors	1-phase motors are not suitable for drive-driven variable speed operation. Use 3-phase motors. * Even if a 1-phase power supply is available, use a 3-phase motor as the drive only provides 3-phase output.
Environmental conditions in combination with peripheral devices	Installation location	Use the drive in a location with an ambient temperature range of -10 to 50°C. The drive and braking resistor surfaces become hot under certain operating conditions. Install the drive on a nonflammable surface such as metal. Ensure that the installation location meets the environmental conditions specified in Chapter 2, Section 2.1 "Operating Environment."
	Installing a GE Circuit Breaker (MCCB)	Install a recommended molded-case circuit breaker or a ground-fault circuit interrupter (GFCI) in the primary circuit of the drive to protect the wiring. Ensure that the circuit breaker rating is equivalent to or lower than the recommended rating.
	Magnetic contactor in the secondary circuit	If a magnetic contactor is mounted in the drive's secondary circuit for switching the motor to commercial power, or for any other purpose, ensure that both the drive and the motor are fully stopped before operating this contactor.
	Magnetic contactor in the primary circuit	Do not switch on/off the magnetic contactor in the primary circuit more than once an hour as a drive fault may result. If frequent starts or stops are required during motor operation, use FWD/REV signals or the RUN/STOP key.

Environmental conditions in combination with peripheral devices (continued)	Protecting the motor	When using a motor with a drive, the motor can be protected using the electronic thermal control ability of the drive. In addition to the operation level, set the motor type (standard motor or drive motor). For high-speed motors or water-cooled motors, set a small value for the thermal time constant and protect the motor in combination with the “cooling system OFF” signal. When driving several motors with a drive, connect a thermal relay to each motor and turn on the drive’s electronic thermal relay function. If you connect the motor thermal relay to the motor through a long cable, a high-frequency current may flow in the wiring due to its increased capacitance. This could cause the relay to trip at a current lower than the set value for the thermal relay. In this case, lower the carrier frequency or use an output circuit filter (OFL).
Combination with peripheral device wiring	Power factor correcting capacitor	Do not install power factor correcting capacitors in the drive primary circuit. (Use a dc reactor to improve the drive power factor.) Do not use power factor correcting capacitors in the drive output circuit. An over-current trip will occur, disabling motor operation.
	Reducing noise	Use of a filter and shielded wires are typical measures against noise to ensure that electro-magnetic interference standards are met.
	Measures against surge currents	If an overvoltage trip occurs while the drive is stopped or operated under a light load, it is assumed that the surge current is generated by the open/close action of the phase-advancing capacitor in the power system. * Connect a dc reactor to the drive.
	Megger test	When checking the insulation resistance of the drive, use a 500V megger and follow the instructions contained in Chapter 7, Section 7.4 “Insulation Test.”
	Control circuit wiring length	When using remote control, limit the wiring length between the drive and operator box to 20 m/65 ft or less, and use twisted or shielded cable.
	Wiring length between drive and motor	If extended length wiring is used between the drive and the motor, the drive will overheat or trip as a result of over-current (high-frequency current flowing due to cable capacitance) in the wires connected to the phases. Ensure that the wiring is shorter than 50 m/162 ft. If this distance must be exceeded, lower the carrier frequency or include an output circuit filter (OFL).
	Wiring size	Select cables with an adequate capacity by referring to the current value or recommended wire size.
	Grounding	Securely ground the drive using the grounding terminal.
Selecting drive capacity	Driving standard motor	Select a drive with a capacity range corresponding to the applicable motor rating as shown in the standard specifications table for the drive. When high starting torque is required, or quick acceleration or deceleration needed, select a drive with a capacity one size greater than the standard.
	Driving special motors	Select a drive that that has a rated current exceeding that of the motor
Transportation and storage		For details about transportation and storage of the drives, refer to Chapter 1, Section 1.3 “Transportation” and Section 1.4 “Storage Environment.”

## Terms

The following terms are used throughout this manual.

**NOTE:** This term indicates information which must be taken into account for full efficiency operation of the drive, and information concerning incorrect operation and settings which can result in accidents.

**TIP:** This term indicates information that can prove handy when performing certain settings or operations.

**REFERENCE:** This term indicates a reference to more detailed information.

## **How this manual is organized**

---

This manual consists of chapters 1 through 10.

### **1 Before Using the Drive**

This chapter describes acceptance inspection and precautions for transportation and storage of the drive.

### **2 Mounting and Wiring the Drive**

This chapter covers operating environment, precautions for installing the drive, and wiring instructions for the motor and drive.

### **3 Operation Using the Keypad**

This chapter describes drive operation using the keypad. The drive features three operation modes (Run, Program and Alarm modes) which enable you to run and stop the motor, monitor run status, set function code data, display run information required for maintenance, and display alarm data.

### **4 Operation**

This chapter describes preparations to be made before testing the motor, and practical operation.

### **5 Function Codes**

This chapter provides a list of the function codes. Both common and special function codes are described individually.

### **6 Troubleshooting**

This chapter describes troubleshooting procedures to be followed when the drive malfunctions or detects an alarm condition. First check whether or not an alarm code is displayed, and then proceed to the troubleshooting items.

### **7 Maintenance and Inspection**

This chapter describes inspection, measurement and insulation tests which are required for safe drive operation. It also provides information about periodical replacement parts and guarantee of the product.

### **8 Specifications**

This chapter lists specifications including output ratings, control system, external dimensions and protective functions.

### **9 List of Peripheral Equipment and Options**

This chapter describes main peripheral equipment and options which can be connected to the AF-300 Mini series of drives.

# AF-300 Mini Model Numbering System Diagram

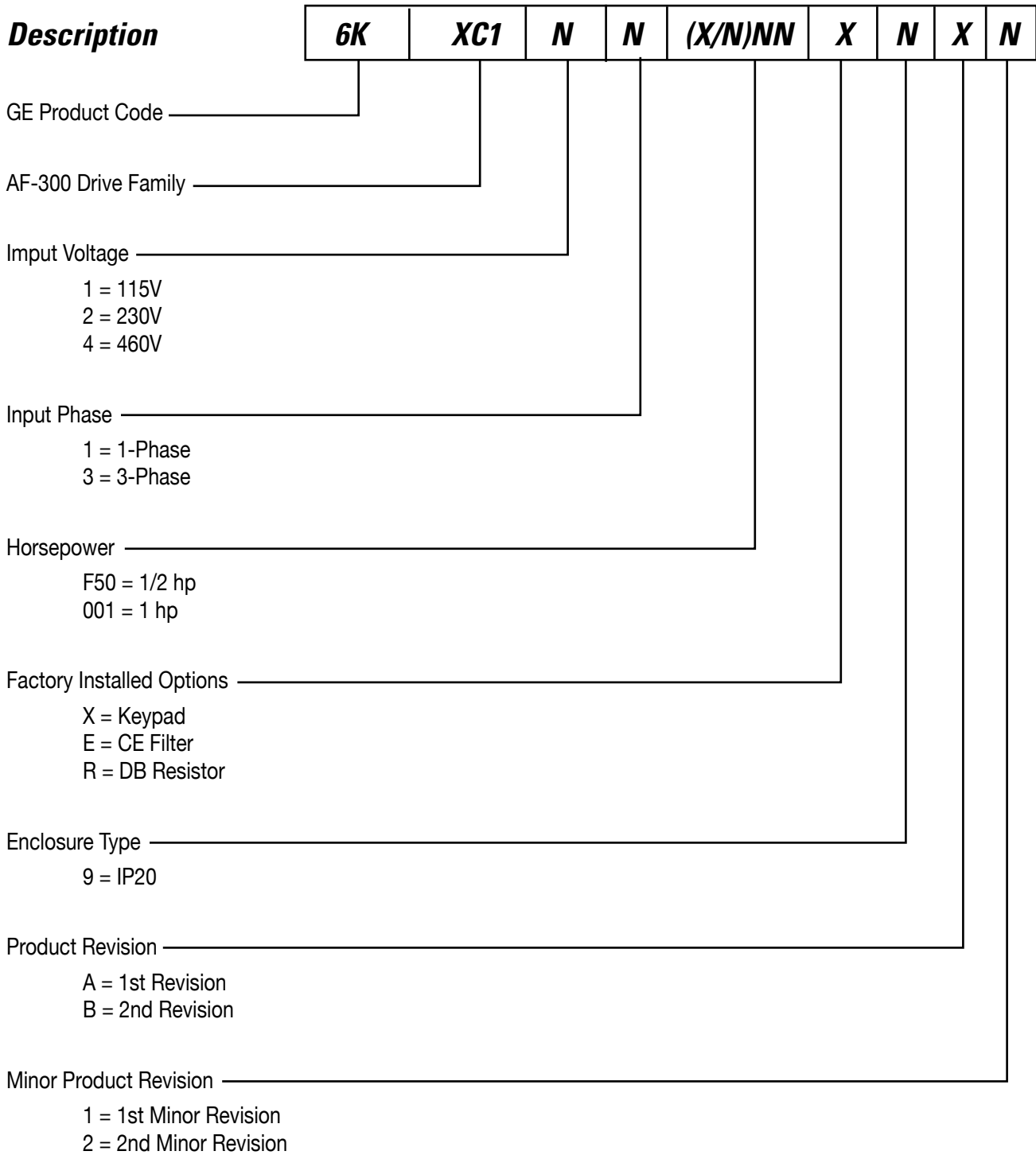

## AF-300 Mini Weights and Dimensions

<b>IP 20 - Protected Enclosure</b>							
<b>Hp Rating</b>	<b>Enclosure</b>	<b>Rated Output Current (A)</b>	<b>Overload (150%)</b>	<b>Model Number</b>	<b>Catalog Number</b>	<b>H x W x D (in)</b>	<b>Weight (lbs)</b>
<b>115 Vac, 1-Phase, 50/60Hz Input</b>							
1/8	IP20	0.7	1.1	6KXC111F12X9 **	D7201	4.72 x 3.15 x 3.94	1.3
1/4	IP20	1.4	2.1	6KXC111F25X9 **	D7202	4.72 x 3.15 x 3.94	1.3
1/2	IP20	2.5	3.8	6KXC111F50X9 **	D7203	4.72 x 3.15 x 4.53	1.5
1	IP20	4.2	6.3	6KXC111001X9 **	D7204	5.12 x 4.33 x 5.47	2.6
<b>230 Vac, 1-Phase, 50/60Hz Input</b>							
1/8	IP20	0.8	1.2	6KXC121F12X9 **	D7205	4.72 x 3.15 x 3.15	1.3
1/4	IP20	1.5	2.3	6KXC121F25X9 **	D7206	4.72 x 3.15 x 3.15	1.3
1/2	IP20	3	4.5	6KXC121F50X9 **	D7207	4.72 x 3.15 x 3.74	1.3
1	IP20	5	7.5	6KXC121001X9 **	D7208	4.72 x 3.15 x 5.51	1.8
2	IP20	8	12	6KXC121002X9 **	D7209	5.12 x 4.33 x 5.87	3.7
3	IP20	11	16.5	6KXC121003X9 **	D7210	7.09 x 5.51 x 5.47	5.1
<b>230 Vac, 3-Phase, 50/60Hz Input</b>							
1/8	IP20	0.8	1.2	6KXC123F12X9 **	D7211	4.72 x 3.15 x 3.15	1.3
1/4H	IP20	1.5	2.3	6KXC123F25X9 **	D7212	4.72 x 3.15 x 3.15	1.3
1/2	IP20	3	4.5	6KXC123F50X9 **	D7213	4.72 x 3.15 x 3.74	1.3
1	IP20	5	7.5	6KXC123001X9 **	D7214	4.72 x 3.15 x 4.72	1.5
2	IP20	8	12	6KXC123002X9 **	D7215	5.12 x 4.33 x 5.47	3.7
3	IP20	11	16.5	6KXC123003X9 **	D7216	5.12 x 4.33 x 5.47	3.7
5	IP20	17	25.5	6KXC123005X9 **	D7217	7.09 x 5.51 x 5.47	5.1
<b>460 Vac, 3-Phase, 50/60Hz Input</b>							
1/2	IP20	1.5	2.3	6KXC143F50X9 **	D7218	5.12 x 4.33 x 4.53	2.4
1	IP20	2.5	3.8	6KXC143001X9 **	D7219	5.12 x 4.33 x 5.47	2.6
2	IP20	3.7	5.6	6KXC143002X9 **	D7220	5.12 x 4.33 x 5.47	3.7
3	IP20	5.5	8.3	6KXC143003X9 **	D7221	5.12 x 4.33 x 5.47	3.7
5	IP20	9	13.5	6KXC143005X9 **	D7222	7.09 x 5.51 x 5.47	5.1
** Indicates product revision							

## AF-300 Mini Weights and Dimensions (continued)

IP 20 - Protected Enclosure with Internal CE Filter							
Hp Rating	Enclosure	Rated Output Current (A)	Overload (150%)	Model Number	Catalog Number	H x W x D (in)	Weight (lbs)
<b>230 Vac, 1-Phase, 50/60Hz Input</b>							
1/8	IP20	0.8	1.2	6KXC121F12E9 **	D7301	4.72 x 3.15 x 3.94	1.5
1/4	IP20	1.5	2.3	6KXC121F25E9 **	D7302	4.72 x 3.15 x 3.94	1.5
1/2	IP20	3	4.5	6KXC121F50E9 **	D7303	4.72 x 3.15 x 4.53	1.5
1	IP20	5	7.5	6KXC121001E9 **	D7304	5.12 x 4.33 x 5.47	2.6
2	IP20	8	12	6KXC121002E9 **	D7305	7.09 x 5.51 x 7.09	5.3
3	IP20	11	16.5	6KXC121003E9 **	D7306	7.09 x 5.51 x 7.17	6.4
<b>230 Vac, 3-Phase, 50/60Hz Input</b>							
1/8	IP20	0.8	1.2	6KXC123F12E9 **	D7307	4.72 x 3.15 x 3.94	1.5
1/4	IP20	1.5	2.3	6KXC123F25E9 **	D7308	4.72 x 3.15 x 3.94	1.5
1/2	IP20	3	4.5	6KXC123F50E9 **	D7309	4.72 x 3.15 x 4.53	1.5
1	IP20	5	7.5	6KXC123001E9 **	D7310	4.72 x 3.15 x 5.51	1.8
2	IP20	8	12	6KXC123002E9 **	D7311	7.09 x 5.51 x 7.17	5.3
3	IP20	11	16.5	6KXC123003E9 **	D7312	7.09 x 5.51 x 7.17	5.3
5	IP20	17	25.5	6KXC123005E9 **	D7313	7.09 x 5.51 x 7.17	6.4
<b>460 Vac, 3-Phase, 50/60Hz Input</b>							
1/2	IP20	1.5	2.3	6KXC143F50E9 **	D7314	5.12 x 4.33 x 6.22	2.4
1	IP20	2.5	3.8	6KXC143001E9 **	D7315	5.12 x 4.33 x 7.17	2.6
2	IP20	3.7	5.6	6KXC143002E9 **	D7316	7.09 x 5.51 x 7.17	3.7
3	IP20	5.5	8.3	6KXC143003E9 **	D7317	7.09 x 5.51 x 7.17	3.7
5	IP20	9	13.5	6KXC143005E9 **	D7311	7.09 x 5.51 x 7.17	5.1
** Indicates product revision							



# 1. Before Using the Drive

## 1.1 Acceptance Inspection

---

Unpack and check the following items.

- (1) A drive and instruction manual (this manual) is contained in the package.
- (2) The drive is not damaged during transportation – no dents.
- (3) The drive is the model you ordered. You may check the model name printed on the nameplate (see Figure 1.1).

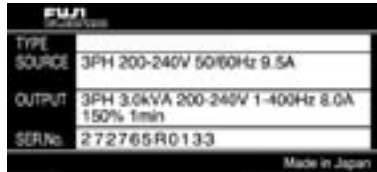

Figure 1.1 Nameplate

INPUT: Number of input phases (3-phase: 3-ph, 1-phase: 1-ph), input voltage, input frequency, input current

OUTPUT: Number of output phases, rated output capacity, rated output voltage, output frequency range, rated output current, overload capacity

SER. NO.: Product number

3 9 0 1 1 2 R 0 0 0 1

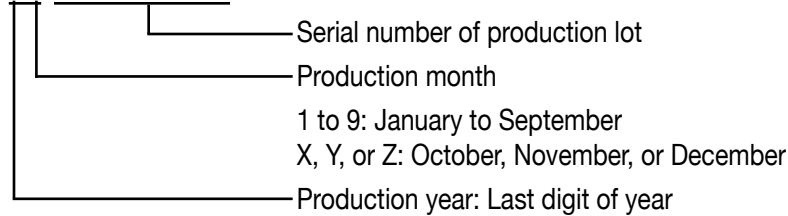

If you suspect the product is not working properly or if you have any questions about it, contact your dealer or GE Fuji.

## 1.2 External View and Terminal Blocks

---

### (1) External views

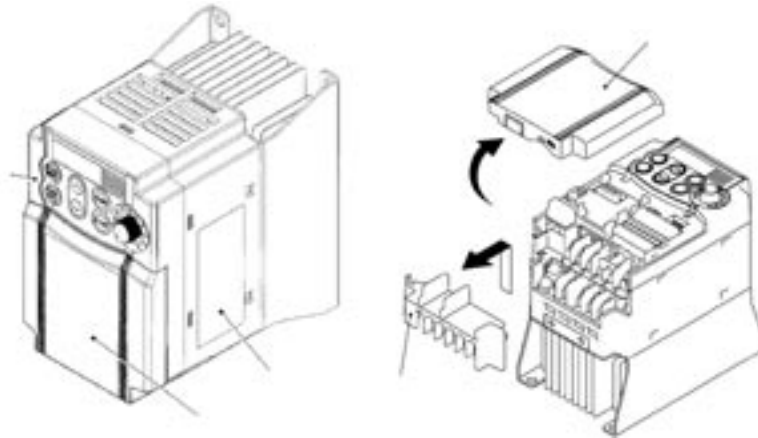
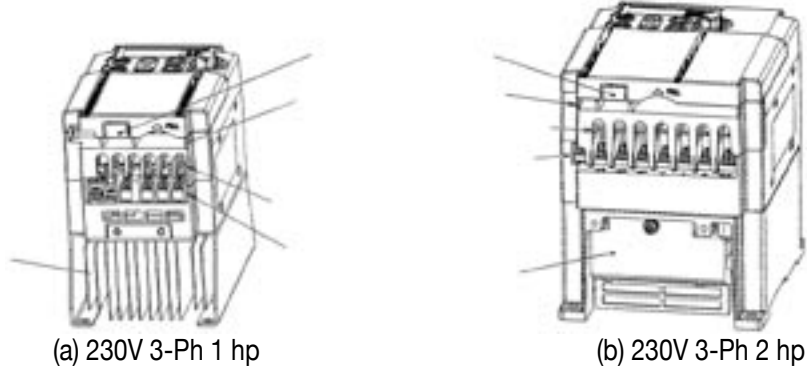

Figure 1.2 External Views of the AF-300 Mini

### (2) View of terminals



(\*When connecting the RS485 (option card) communications cable, remove the control circuit terminal block cover and cut off the barrier provided in it using nippers.)

Figure 1.3 Bottom View of AF-300 Mini

## 1.3 Transportation

---

- When carrying the drive, always support its bottom at the front and rear sides with both hands. Do not hold only by the cover or other parts, since they may detach and allow the drive to drop and break.
- Avoid applying force to the terminal block covers, which are made of plastic and may break easily.

## 1.4 Storage Environment

### 1.4.1 Temporary storage

Store the drive in an environment that satisfies the requirements listed in Table 1.1.

Table 1.1 Environmental Requirements for Storage and Transportation

Item	Requirements	
Storage temperature (*1)	-25 to +65°C (-4 to +149°F)	Places not subjected to abrupt temperature changes or condensation or freezing
Relative humidity	5 to 95%	
Atmosphere	The drive must not be exposed to dust, direct sunlight, corrosive or flammable gases, oil mist, vapor, water drops or vibration. The atmosphere must contain only a low level of salt. (Less than 0.01 mg/cm <sup>2</sup> per year)	
Atmospheric pressure	86 to 106 kPa / 12.5 to 15.4 psi (in storage)	
	70 to 106 kPa / 10.2 to 15.4 psi (during transportation)	
*1: The storage temperature applies only to short periods of time, such as during transportation.		

### Precautions for temporary storage

- (1) Do not place the drive directly on the floor.
- (2) If the storage environment does not meet the specified requirements, wrap the drive in an airtight vinyl sheet or similar for storage.
- (3) If there is a possibility that the drive will be exposed to high humidity, add a drying agent (such as silica gel) in the airtight package described in item (2).

### 1.4.2 Long-term storage

The long-term storage method for the drive varies according to the environment of the storage site. General storage methods are described below.

- (1) The storage site must satisfy the requirements specified for temporary storage.  
However, for storage exceeding three months, the ambient temperature should be within the range of -10 to 30°C (14 to 86°F). This is to prevent electrolytic capacitors in the drive from deterioration.
- (2) The package must be airtight to protect the drive from moisture. Add a drying agent inside the package to maintain the relative humidity inside the package at less than 70%.
- (3) If the drive has been installed to the equipment or control board at construction sites where it may be subjected to humidity, dust or dirt, then remove the drive and store it in a suitable environment.

### Precautions for storage over 1 year

If the drive has not been powered on for a long time its electrolytic capacitors may deteriorate. Power the drives on once a year and keep the drives powered on for 30 to 60 minutes. Do not connect the drives to motors or run the motor.

# ***Notes***

## 2. Mounting and Wiring the Drive

### 2.1 Operating Environment

Install the drive in an environment that meets the requirements listed in Table 2.1.

Table 2.1 Environmental Requirements

Item	Specifications
Site location	Indoors
Ambient temperature	-10 to +50°C (+14 to 122°F)
Relative humidity	5 to 95% (non condensing)
Atmosphere	The drive must not be exposed to dust, direct sunlight, corrosive gases, flammable gas, oil mist, vapor or water drops. (Note 1) The atmosphere must contain only a low level of salt (0.01 mg/cm <sup>2</sup> or less per year). The drive must not be subjected to sudden changes in temperature that will cause condensation to form.
Altitude	1,000 m (3,300 ft) max. (Note 2)
Atmospheric pressure	86 to 106 kPa / 12.5 to 15.4 psi
Vibration	3 mm (max. amplitude 2 to less than 9 Hz)
	9.8 m/s <sup>2</sup> (9 to less than 20 Hz)
	2 m/s <sup>2</sup> (20 to less than 55 Hz)
	1 m/s <sup>2</sup> (5 to less than 200 Hz)

Table 2.2 Output Attenuation Ratio with Altitude

Altitude	Output current derate factor
3300 ft (1000m) or lower	1.00
3300-4950 ft (1000 to 1500 m)	0.97
4950-6600 ft (1500 to 2000 m)	0.95
6600-8250 ft (2000 to 2500 m)	0.91
8250-9900 ft (2500 to 3000 m)	0.88

Note 1: Do not install the drive in an environment where it may be exposed to cotton waste or moist dust or dirt which may clog the heat sink in the drive. If the drive is to be used in such an environment, install it in the control board of your system or in another dust-proof enclosure.

Note 2: If the drive is to be used at an altitude of more than 3,300 ft (1,000 m), derate the output current by the factor listed in Table 2.2 above.

### 2.2 Installing the drive

#### (1) Mounting base

The temperature of the heat sink may rise up to about 90°C during operation of the drive, so it should be mounted on a base made of material that can withstand temperatures at this level.

#### WARNING

Install the drive on a base constructed from metal or other non-flammable material.

**A fire may result with other material.**

#### (2) Clearances

Ensure that the minimum clearances indicated in Figure 2.1 are maintained at all times. When installing the drive in a power control board, take extra care with ventilation inside the control board, as the temperature around the drive will tend to increase.

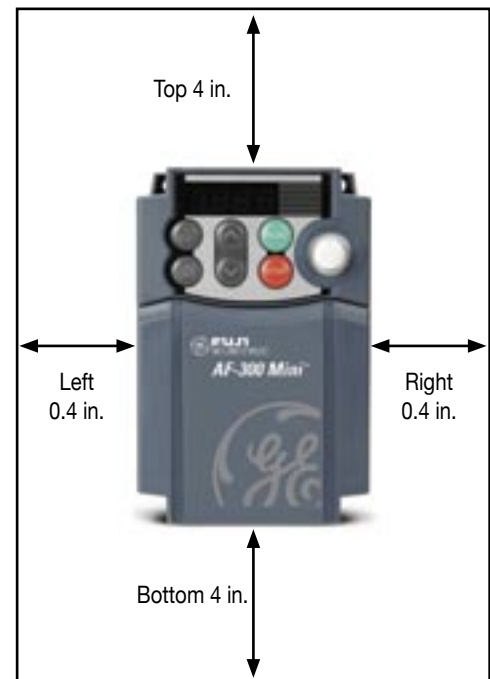

Figure 2.1 Mounting Direction and Required Clearances

### When mounting two or more drives

Horizontal layout is recommended when two or more drives are to be installed in the same enclosure or power control board. As long as the ambient temperature is 40°C (104°F) or lower, drives may be mounted side-by-side without any clearance between them. If it is necessary to mount the drives vertically, install a partition plate or similar divider between the drives so that any heat radiating from one drive will not affect the those above.

### (3) Mounting direction

Secure the drive to the mounting base with four screws or bolts (M4) so that the AF-300 Mini logo faces outwards. Tighten those screws or bolts perpendicular to the mounting base.

Do not mount the drive upside down or horizontally.

## CAUTION

Prevent lint, paper fibers, sawdust, dust, metallic chips, or other foreign materials from getting into the drive or from accumulating on the heatsink.

**This may result in a fire or accident.**

## 2.3 Wiring

---

Follow the procedure below. (In the following description, the drive has already been installed.)

### 2.3.1 Removing the Terminal Block (TB) Covers

(1) Removing the control circuit terminal block (TB) cover

Insert your finger in the cutout (near "PULL") in the bottom of the control circuit TB cover, then pull the cover towards you.

(2) Removing the main circuit terminal block (TB) cover

Hold both sides of the main circuit TB cover between thumb and forefinger and slide it towards you.

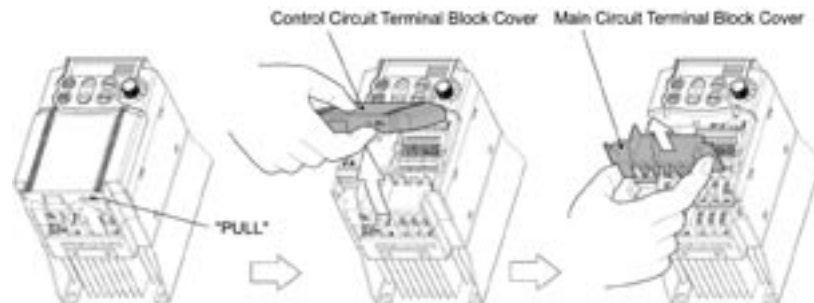



Figure 2.2 Removing the Terminal Block (TB) Covers

### 2.3.2 Terminal Arrangement and Screw Specifications

The figures below show various arrangements of the main and control circuit terminals. This differs according to drive type. The two ground terminals provided, indicated by the symbol  in Figures A to D, may be used interchangeably for either the power supply side (primary circuit) or the motor side (secondary circuit).

#### (1) Arrangement of the main circuit terminals

Power supply voltage	Applicable motor & drive rating (hp)	Refer to:
3-phase 230V	1/8 hp	Figure A
	1/4 hp	
	1/2 hp	
	1 hp	
	2 hp	
3-phase 460V	3 hp	Figure B
	5 hp	
	1/2 hp	
	1 hp	
1-phase 230V	2 hp	Figure C
	3 hp	
	1/8 hp	
	1/4 hp	
	1/2 hp	
1-phase 115V	1 hp	Figure D
	1/2 hp	
	1/4 hp	
	1/8 hp	

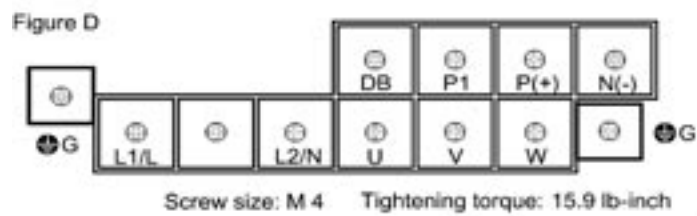
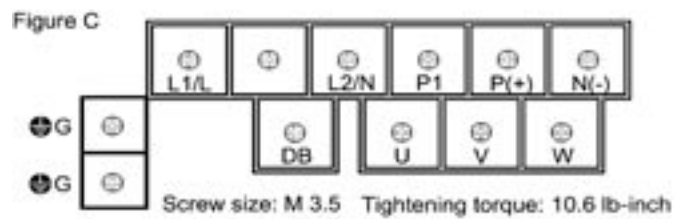
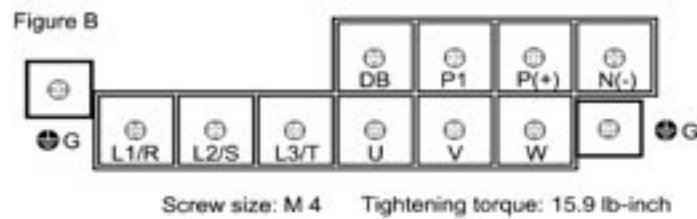
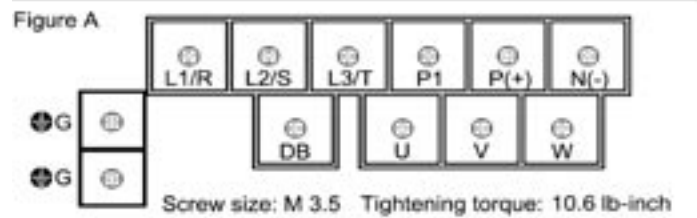

**(2) Arrangement of the control circuit terminals (common to all AF-300 Mini models)**

Y1	Y1E	FMA	C1	PLC	X1	X2	X3
----	-----	-----	----	-----	----	----	----

11	12	13	11	CM	FWD	REV	CM
----	----	----	----	----	-----	-----	----

30A	30B	30C
-----	-----	-----

Screw size: M 2 Tightening Torque: 1.8 lb-inch

Screw size: M 2.5 Tightening Torque: 3.5 lb-inch

Terminal	Screwdriver to be used	Allowable wire size	Strip length of wire covering	Dimension of openings in the control circuit terminals for stick terminals
30A, 30B, 30C	Phillips screwdriver equivalent to #1 size	18 to 22 AWG (0.34 to 0.75 mm <sup>2</sup> )	0.24 to 0.31" (6 to 8 mm)	0.11" (W) x 0.07" (H) (2.7 mm x 1.8 mm)
Others	Phillips screwdriver for precision machinery equivalent to #0 size	18 to 22 AWG (0.25 to 0.75 mm <sup>2</sup> )	0.2 to 0.28" (5 to 7 mm)	0.07" (W) x 0.06"(H) (1.7 mm x 1.6 mm)

**2.3.3 Wiring Precautions**

Follow the rules below when wiring the drive.

- (1) Make sure that the supply voltage is within the range specified on the nameplate.
- (2) Be sure to connect the power wires to the main circuit power input terminals L1/R, L2/S and L3/T (for 3-phase voltage input) or L1/L and L2/N (for 1-phase voltage input) of the drive. If the power wires are connected to other terminals, the drive will be damaged when the power is turned on.
- (3) Always connect the ground terminal to prevent electric shock, fire or other disasters and to reduce electric noise.
- (4) Use solderless terminals for the main circuit terminal wiring to ensure a reliable connection.
- (5) Keep the power supply wiring (primary circuit) and motor wiring (secondary circuit) of the main circuit, and control circuit wiring as far away from each other as possible.

**WARNING**

- Always connect ground wires.  
**Failure to do so may result in electric shock or fire.**
- Qualified electricians should always perform the wiring.
- Check that the power is turned off before proceeding with any wiring  
**Failure to do so may result in electric shock.**

**CAUTION**

- Check that the number of phases and the rated voltage of the drive match those of the ac power.  
**Failure to do so may result in a fire.**
- Do not connect the ac power line to the drive output terminals U, V, and W.  
**Doing so may result in injury.**
- Do not connect a braking resistor to the dc link circuit terminals P(+) and N(-).  
**Doing so may result in a fire.**



### 2.3.4 Wiring for Main Circuit Terminals and Ground Terminals

Follow the procedure below. Figure 2.3 illustrates the wiring for peripheral equipment.

#### Wiring Procedure

- (1) Ground terminals  $\blacksquare$ G
- (2) Drive output terminals (U, V, and W)
- (3) DC reactor connection terminals (P1 and P(+))\*
- (4) Braking resistor connection terminals (P(+)) and DB)\*
- (5) DC link circuit terminals (P(+) and N(-))\*
- (6) Main circuit power input terminals (L1/R, L2/S and L3/T) or (L1/L and L2/N)

\*Wire these as necessary.

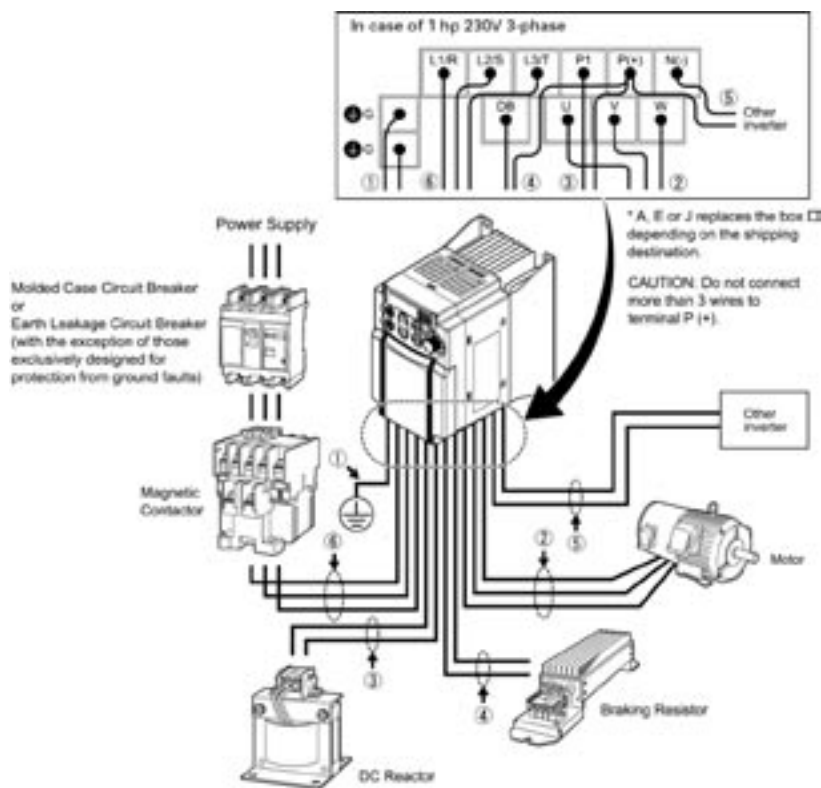

Figure 2.3 Wiring Procedure for Peripheral Equipment

The wiring procedure for the 6KXC \_\_\_\_\_ is shown below as an example. For other drive types, perform wiring in accordance with their individual terminal arrangement. (Refer to page 2-3.)

**(1) Ground terminals (G)**

For safety and noise reduction, be sure to connect either of the two ground terminals. Electric Codes specify that all metal frames of electrical equipment must be grounded to avoid electric shock, fire and other disasters.

Ground terminals should be wired as follows:

- 1) Connect the ground terminal of the drives to a ground in compliance with your applicable local Electric Codes.
- 2) Connect a thick ground wire with a large surface area and keep the wiring length as short as possible.

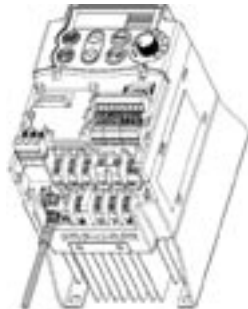

Figure 2.4 Ground Terminal Wiring

**(2) Drive output terminals, U, V, and W**

- 1) Connect the three wires of the 3-phase motor to terminals U, V, and W, aligning phases each other.
- 2) The wiring length between the drive and motor should not exceed 50 m (165 ft). If the wiring length exceeds that length, it is recommended that an output circuit filter (option) be inserted.

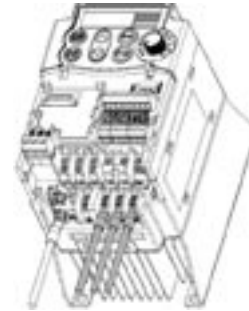
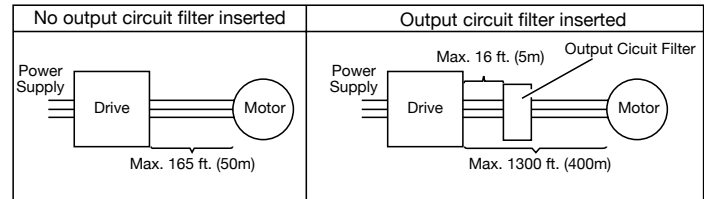

Figure 2.5 Drive Output Terminal Wiring



**NOTE:** Do not connect a power factor improvement capacitors or surge absorber to the drive output terminals.

If the wiring length is excessive, stray capacitance between the wires will increase, resulting in high leakage current. This may activate the overcurrent protection, increase leakage current, or degrade the accuracy of the current display.

If more than one motor is to be connected to a single drive, the allowable wiring length is the combined length of all the wires to the motors.

**NOTE: Driving a 460V motor**

If a thermal relay is installed in the path between the drive and the motor, the thermal relay may malfunction even with a wiring length shorter than 165 ft (50 m). In this situation, add an output circuit filter (option) or lower the carrier frequency (Function Code F26: Motor sound (sound tune)).

If the motor is driven by a PWM-type drive, surge voltage that is generated by switching the drive component may be superimposed on the output voltage and thus applied to the motor terminals. Particularly if the wiring length is long, this surge voltage may deteriorate the insulation resistance of the motor.

Consider any of the following measures:

- 1) Use a motor with 1300V insulation.
- 2) Connect an output circuit filter (option) to the output terminals of the drive.
- 3) Take steps to minimize the wiring length between the drive and motor .

### (3) DC reactor terminals, P1 and P (+)

- 1) Remove the jumper bar from terminals P1 and P(+).
- 2) Connect a dc reactor (option) to terminals P1 and P(+).

NOTE: If a dc reactor is to be connected to a braking resistor, attach both wires of the dc reactor and braking resistor together to terminal P(+). (See next page)

Do not remove the jumper bar if a dc reactor is not used.

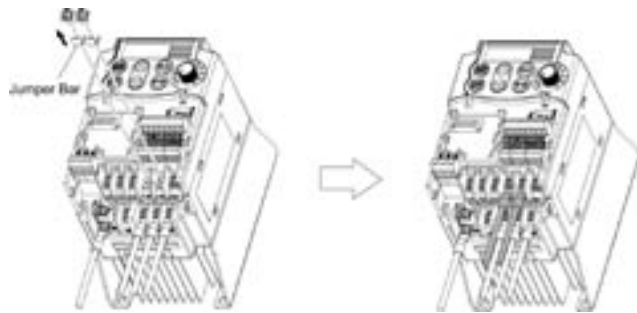

Figure 2.6 DC Reactor Connection

### (4) Braking resistor terminals, P(+) and DB

NOTE: Do not connect a braking resistor to any drive with a rated capacity of 1/8 or 1/4 hp. (If connected, the braking resistor will not work.)

- 1) Connect terminals P and DB of the built-in braking resistor (available to order) or external braking resistor (option) to terminals P(+) and DB on the main circuit terminal block.
- 2) When using an external braking resistor, arrange the drive and braking resistor to keep the wiring length to 5 m or less, and twist the two wires or route them together in parallel.

### When a dc reactor is not to be connected together with the braking resistor

- 1) Remove the screws from terminals P1 and P(+), together with the jumper bar.
- 2) First connect the wire from terminal P of the braking resistor to terminal P(+), then the jumper bar, and secure them with the screw removed in 1) above.
- 3) Tighten the screw on terminal P1.
- 4) Connect the wire from terminal DB of the braking resistor to the DB of the drive.

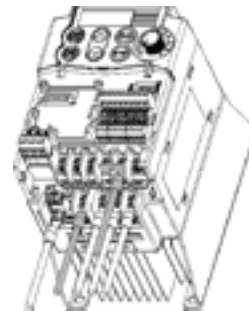

Figure 2.7 Braking Resistor Connection without DC Resistor

### When connecting a dc reactor together with the braking resistor

- 1) Remove the screw from terminal P(+).
- 2) Overlap the dc reactor wire and braking resistor wire (P) as shown at left and then secure them to terminal P(+) of the drive with the screw.
- 3) Connect the wire from terminal DB of the braking resistor to terminal DB of the drive.
- 4) Do not use the jumper bar.



Figure 2.8 Braking Resistor Connection with DC Resistor

### When using an optional internal braking resistor

An optional internal braking resistor should be connected to terminals P(+) and DB. Connect the wires from the braking resistor, following the procedure described in “When a dc reactor is not to be connected together with the braking resistor” or “When using a dc reactor together” on the previous page, as applicable.

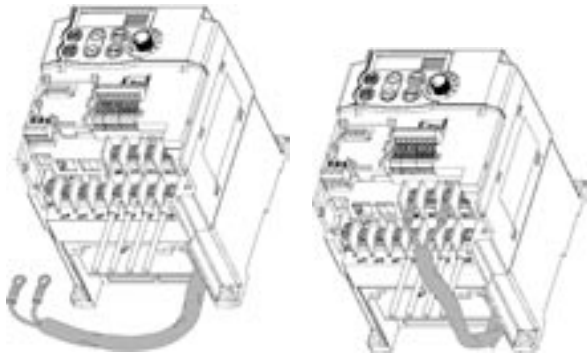

Figure 2.9 Braking Resistor Connection

TIP: The optional internal braking resistor type is available only in 3-phase 230V and 460V models of 2 hp and above.

#### (5) DC link circuit terminals, P (+) and N (-)

These are provided for the dc bus link circuit system. Connect these terminals with terminals P(+) and N (-) of other drives.

NOTE: Consult GE Fuji if these terminals are to be used.

#### (6) Main circuit power input terminals, L1/R, L2/S, and L3/T (for 3-phase voltage input) or L1/L and L2/N (for 1-phase voltage input)

- 1) For safety, make sure that the Molded Case Circuit Breaker (MCCB) or Magnetic Contactor (MC) is disconnected before wiring the main circuit power input terminals.
- 2) Connect the ground wire of the main circuit power input terminals (L1/R, L2/S and L3/T or L1/L and L2/N) to the ground terminal (G).
- 3) Connect the main circuit power supply wires (L1/R, L2/S and L3/T or L1/L and L2/N) to the input terminals of the drive via an MCCB or Ground Fault Circuit Interrupter (GFCI), and MC if necessary.

It is not necessary to align phases of the power supply wires and the input terminals of the drive with each other.

TIP: It is recommended that a manual on/off magnetic contactor be connected. This is to enable you to disconnect the drive from the power supply in an emergency (e.g. when the protective function is activated) so as to prevent accidents or damage.

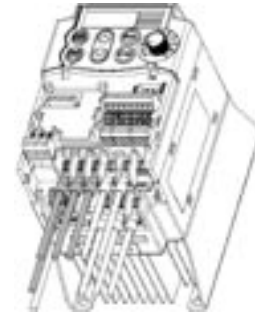

Figure 2.10 Main Circuit Power Input Terminal Connection

### 2.3.5 Replacing the Main Circuit Terminal Block (TB) Cover

- 1) As shown in Figure 2.11, pull out the wires from the main circuit terminals in parallel.
- 2) Hold both sides of the main circuit TB cover between thumb and forefinger and slide it back into place. Pull the wires out through the grooves of the main circuit TB cover.

NOTE: When replacing the main circuit TB cover, take care not to apply any stress to the wires. Stress on the wires imposes a mechanical force on the main circuit terminal screws, loosening them.

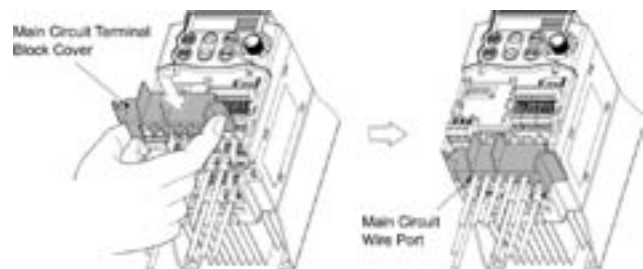

Figure 2.11 Replacing the Main Circuit Terminal Block (TB) Cover

## 2.3.6 Wiring for Control Circuit Terminals

### Warning

The outer jacket of control circuit cable is generally not insulated for high voltage levels. Therefore if the control circuit cabling comes into direct contact with the live main circuit terminal, the insulation may be insufficient. Accordingly, there is a possibility that DANGEROUSLY high voltage from the main power circuit could be applied to the control circuit wires. Be sure to keep the control wires away from the live main circuit terminals.

**An accident or electric shock could occur.**

### Caution

Noise may be emitted from the drive, motor and wires. Implement appropriate measures to prevent malfunctioning due to noise.

**An accident could occur.**

Table 2.4 lists the symbols, names and functions of the control circuit terminals. The wiring to the control circuit terminals may differ depending upon drive set-up using function codes.



Figure 2.12 Example of Control Circuit Wiring

Replace the main circuit TB cover and then connect wires to the control circuit terminals. As shown in Figure 2.12, pull the wires out through the guides on the main circuit TB cover. Route these wires correctly to reduce the influence of noise, referring to the notes on the following pages.

Table 2.4 Symbols, Names and Functions of the Control Circuit Terminals

Classification	Symbol	Name	Functions
Analog input	[13]	Potentiometer power supply	Power supply (+10 Vdc) for frequency command potentiometer (Potentiometer: 1 to 5 kΩ) Allowable output current: 10 mA
	[12]	Voltage input	(1) The frequency is set according to the external analog input voltage. 0 to +10 (Vdc)/0 to 100 (%) (Normal mode operation) +10 to 0 (Vdc)/0 to 100 (%) (Inverse mode operation) (2) Used for reference signal (PID process command) or PID feedback signal. (3) Used as additional auxiliary setting for various main frequency commands. * Input impedance: 22 kΩ * Allowable maximum input voltage is 15 Vdc. If the input voltage is 10 Vdc or over, the drive assumes it to be 10 Vdc.
	[C1]	Current input	(1) The frequency is set according to the external analog input current command. 4 to 20 (mA dc)/0 to 100 (%) (Normal mode operation) 20 to 4 (mA dc)/0 to 100 (%) (Inverse mode operation) (2) Used for reference signal (PID process command) or PID feedback signal. (3) Connects PTC thermistor for motor protection. (4) Used as additional auxiliary setting to various main frequency commands. * Input impedance: 250 Ω * Allowable input current is 30 mA dc. If the input current exceeds 20 mA dc, the drive will limit it at 20 mA dc.
	[11]	Analog common	Common terminal for analog input and output signals

NOTE: The control signal lines handle weak analog signals that are susceptible to external noise and interference, so use shielded wires and keep them as short as possible (less than 66 ft / 20 m). It is recommended that the shielding conductor of those wires be grounded. If grounding causes control signals to be affected by external induction noise, connect the shield to terminal [11], which may be effective for noise reduction. As shown in Figure 2.13, ground the single end of the shield to enhance the shielding effect.

Use a twin contact relay for weak signals if a relay is used in the circuit. Do not connect the relay's contact to terminal [11].

When the drive is connected to an external device putting out an analog signal, malfunctions may be caused by electric noise generated by the drive. If this happens, depending on the circumstances, connect a ferrite core (a ring core or its equivalent) to the device outputting the analog signal and/or connect a capacitor with good cut-off characteristics for high frequency between the control signal cables, as shown in Figure 2.14.

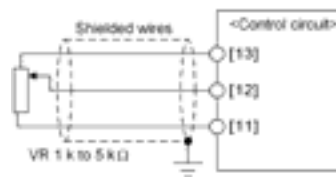

Figure 2.13 Connection of Shielded Wire

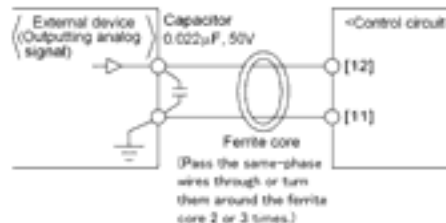

Figure 2.14 Example of Electric Noise Prevention

Table 2.4 Continued

Classification	Symbol	Name	Functions
Analog input	[X1]	Digital input 1	(1) The various signals such as coast-to-stop, alarm from external equipment, and multistep frequency selection can be assigned to terminals [X1] to [X3], [FWD] and [REV] by setting function codes E01 to E03, E98, and E99. For details, refer to Chapter 5, Section 5.2 "Overview of Function Codes." (2) Input mode, i.e. Sink/Source, is changeable by using the built-in jumper switch. (3) Switches the logic value (1/0) for ON/OFF of the terminals between [X1] to [X3], [FWD] or [REV], and [CM]. If the logic value for ON between [X1] and [CM] is 1 in the normal logic system, for example, OFF is 1 in the negative logic system and vice-versa. Digital input circuit specifications
	[X2]	Digital input 2	
	[X3]	Digital input 3	
	[FWD]	Forward operation command	
	[REV]	Reverse operation command	
	[PLC]	PLC signal power	Connects to PLC output signal power supply. (Rated voltage: 24 Vdc; Maximum output current: 50 mA)
	[CM]	Digital input common	Common terminal for digital input signals

Item		Min.	Max.
Operation voltage (SINK)	ON level	0V	2V
	OFF level	22V	27V
Operation voltage (SOURCE)	ON level	22V	27V
	OFF level	0V	2V
Operation current at ON (Input Voltage at 0V)		2.5 mA	5 mA
Allowable leakage current at OFF		-	0.5 mA

TIP: As shown in Figure 2.15, the digital input terminals [X1] to [X3], [FWD] and [REV] can be switched on or off with the open collector transistor outputs by connecting the power input (+) of the external device, such as a PLC, to terminal [PLC] that supplies power to the device.

To do so, switch the jumper to SINK.

NOTE: Do not connect terminal [CM] of the drive to the common terminal of a programmable controller.

NOTE: To switch terminals [X1] through [X3], [FWD] and [REV] on or off with contact input, use reliable contacts.

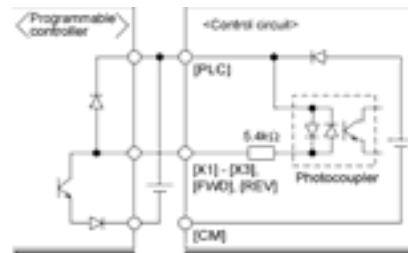
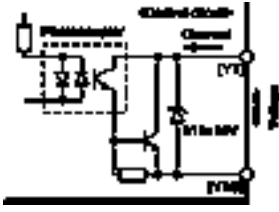

Figure 2.15 External Power Supply Connection

Table 2.4 Continued

Classification	Symbol	Name	Functions														
Analog output	[FMA]	Analog monitor	The monitor signal for analog dc voltage (0 to +10 Vdc) is output. The signal functions can be selected from the following with function code F31. - Output frequency (before slip compensation) - Output frequency (after slip compensation) - Output current - Output voltage - Power consumption - PID feedback value - Intermediate dc circuit voltage - Analog output test (+) *Input impedance of external device: Max. 5 kΩ														
	[11]	Analog common	Common terminal for analog input and output signals														
Transistor Output	[Y1]	Transistor output	(1) Various signals such as drive run status, speed/freq. arrival and overload early warning can be assigned to the terminal [Y1] by setting function code E20. Refer to the Section 5.2 in Chapter 5 titled "Overview of Function Codes" for details. (2) Switches the logic value (1/0) for ON/OFF of the terminals [Y1] and [Y1E]. If the logic value for ON between [Y1] and [Y1E] is 1 in the normal logic system, for example, OFF is 1 in the negative logic system and vice versa.  Digital input circuit specification  <table border="1" data-bbox="873 787 1274 1123"> <thead> <tr> <th colspan="2">Item</th> <th>Max.</th> </tr> </thead> <tbody> <tr> <td rowspan="2">Operation voltage</td> <td>ON level</td> <td>2V</td> </tr> <tr> <td>OFF level</td> <td>27V</td> </tr> <tr> <td colspan="2">Maximum load current at ON</td> <td>50 mA</td> </tr> <tr> <td colspan="2">Leakage current at OFF</td> <td>0.1 mA</td> </tr> </tbody> </table> Note: Check the polarity of the external power inputs. When connecting a control relay, first connect a surge-absorbing diode across the coil of the relay.	Item		Max.	Operation voltage	ON level	2V	OFF level	27V	Maximum load current at ON		50 mA	Leakage current at OFF		0.1 mA
	Item		Max.														
Operation voltage	ON level	2V															
	OFF level	27V															
Maximum load current at ON		50 mA															
Leakage current at OFF		0.1 mA															
	[Y1E]	Transistor output common	Common terminal for transistor output signal (Isolated from terminals [CM] and [11].)														
Relay output	[30A], [30B], [30C]	Alarm relay output (for any fault)	(1) Outputs a contact signal [1C] (SPDT) when a protective function has been activated to stop the motor. Contact rating: 250 Vac 0.3 A cos (= 0.3), 48 Vdc, 0.5A (2) A command similar to terminal [Y1] can be selected for the transistor output signal and use it for signal output. (3) Switching of the normal/negative logic output is applicable to the following two contact outputs: "Terminals [30A] and [30C] are short-circuited for ON signal output" or "the terminals [30B] and [30C] are short-circuited (non-excite) for ON signal output."														
Communication	RS485 port*	RS485 communications I/O	(1) Used to connect the drive with PC or PLC using RS485 port. (2) Used to connect the drive with the remote keypad. The drive supplies the power to the remote keypad through the extension cable for remote keypad.														

\* This terminal can be used with standard drives equipped with an RS485 communications card (option).

NOTE: Route the wiring of the control terminals as far from the wiring of the main circuit as possible in order to prevent malfunctioning resulting from interference and noise.

Fix or bind the control cables inside the drive so that they are kept away from the live parts of the main circuit (such as the main circuit terminal block).



### 2.3.7 Switching of SINK/SOURCE (Jumper Bar)

#### Warning

Before changing the jumper bar, wait for at least five minutes after the power has been turned off, then check with a multimeter that the dc voltage between main circuit terminals P (+) and N (-) does not exceed a safe voltage (25 V). An electric shock may result if this warning is not heeded as there can be residual electric charge in the intermediate dc circuit capacitor even after the power has been turned off.

To switch the sink/source of the input signal, change the positioning of the jumper bar using a pair of long-nose pliers, as shown in Figure 2.16.

At the factory setting, the jumper bar is positioned at SINK.

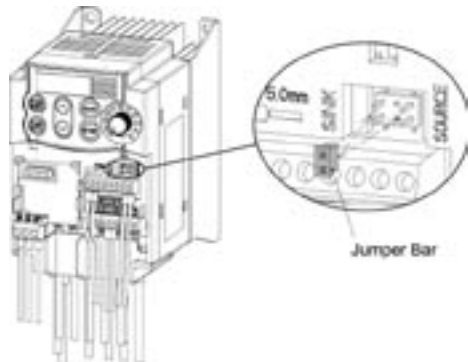

Figure 2.16 Switching of SINK/SOURCE (Jumper Bar)

### 2.3.8 Installing an RS485 Communications Card (Option)

When an optional RS485 communications card is to be used, install it before replacing the main circuit TB cover. Align the card with the latch on the drive and attach the card to the connector that is located above terminals [30A], [30B] and [30C].

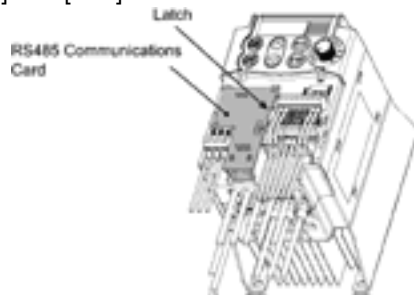
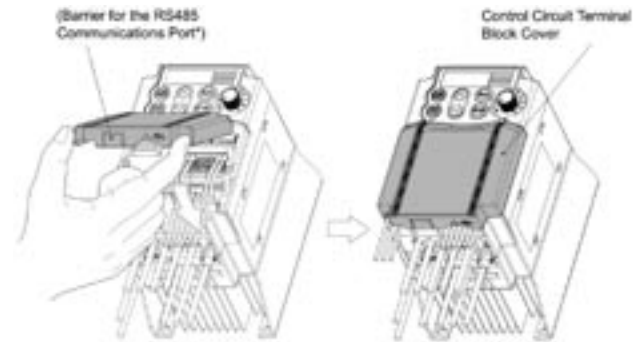

Figure 2.17 Installing an RS485 Communications Card (Option)

### 2.3.9 Replacing the Control Circuit Terminal Block (TB) Cover

Upon completion of the wiring of the control circuits, fit the latches provided on the upper end of the control circuit TB cover into the openings in the front face of the drive, and then close the TB cover.

NOTE: Take care not to pinch the signal lines between the TB cover and drive body.



(\*When connecting the RS485 communications cable, remove the control circuit TB cover and snip off the barrier of the RS485 communications cable port using nippers.)

Figure 2.18 Replacing the Control Circuit Terminal Block (TB) Cover

### 2.3.10 Cautions Relating to Harmonic Component, Noise, and Leakage Current

#### (1) Harmonic component

Input current to a drive includes a harmonic component, which may affect other loads and power factor improvement capacitors that are connected to the same power supply. If the harmonic component causes any problems, connect a dc reactor (option) to the drive. It may also be necessary to connect an ac reactor to the power factor improvement capacitors.

#### (2) Noise

If noise generated from the drive affects other devices, or that generated from peripheral equipment causes the drive to malfunction, follow the basic measures outlined below.

- 1) If noise generated from the drive affects the other devices through power wires or grounding wires:
  - Isolate the grounded metal frame of the drive from other devices.
  - Connect a noise filter to the drive power wires.
  - Isolate the power system of the other devices from that of the drive with an isolating transformer.
- 2) If induction or radio noise generated from the drive affects other devices through power wires or grounding wires:
  - Isolate the main circuit wires from the control circuit wires and other device wires.
  - Put the main circuit wires through a metal conduit and connect the pipe to the ground near the drive.

- Mount the drive onto the metal board and connect the whole board to ground.
  - Connect a noise filter to the drive power wires.
- 3) When implementing measures against noise generated from peripheral equipment:
- For the control circuit wires, use twisted or shielded-twisted wires. If using shielded-twisted wires, connect the shield of the shielded wires to the common terminals of the control circuit.

- Connect a surge absorber in parallel with the coil or solenoid of the magnetic contactor.

**(3) Leakage current**

Harmonic component current generated by transistors (IGBT) in the drive switching ON/OFF becomes leakage current through stray capacitance of the drive input and output wires or the motor. If any of the problems listed below occur, take appropriate measures against them.

Table 2.5 Leakage Current Countermeasures

Problem	Measures
A ground fault circuit interrupter* (GFCI) that is connected to the power supply has isolated the drive from the power supply.	Decrease the carrier frequency. 2) Make the wires between the drive and motor shorter. 3) Use a less sensitive ground fault circuit interrupter. 4) Use a ground fault circuit interrupter that includes protection against harmonic component.
An external thermal relay was activated.	1) Decrease the carrier frequency. 2) Increase thermal time constant. 3) Use the thermal relay built in the drive.

### 2.3.11 Recommended Wire Sizes

Table 2.5 lists the recommended wire sizes. The wire size for the main circuit denotes the values for 75° C Cu wires at an ambient temperature of 50°C.

Table 2.6 Recommended Wire Size

Power supply voltage	Symbol	Name	Recommended wire size (AWG) *1				Control circuit
	Applicable motor rating (hp)	Drive hp	Main circuit				
			Main power circuit input [L1/R, L2/S and L3/T] [L1/L and L2/N] Grounding [G]		Drive output [U, V and W]	DC reactor [P1 and P (+)] Braking resistor [P (+) and DB]	
			w/ dc reactor	w/o dc reactor *2			
3-phase 230 V	1/8 to 3 hp	1/8 to 3 hp	14	14	14	14	20
	5 hp	5 hp		14	14	12	
3-phase 460 V	1/2 to 5 hp	1/2 to 5 hp	14	14	14	14	
1-phase 230 V	1/8 to 1 hp	1/8 to 1 hp	14	14	14	14	
	2 hp	2 hp		14		14	
	3 hp	3 hp	14	12		14	
1-phase 115 V	1/8 to 1/2 hp	1/8 to 1/2 hp	14	14	14	14	
	1 hp	1 hp		14	14	14	

\*1 Use solderless terminals covered with an insulated jacket or insulating sleeve.

\*2 Wire sizes are calculated on the basis of input RMS current under the condition that power supply capacity and impedance are 500 kVA and 5%, respectively.

# ***Notes***

### 3. Operation Using the Keypad

#### 3.1 Keys, Potentiometer, and LED on the Keypad

As shown in the figure at below, the keypad consists of an LED monitor, a potentiometer (POT), and six keys.

The keypad allows you to run and stop the motor, monitor running status, and switch to the menu mode. In the menu mode, you may set the function code data to match your operating requirements and monitor I/O signal states, maintenance information, and alarm information.

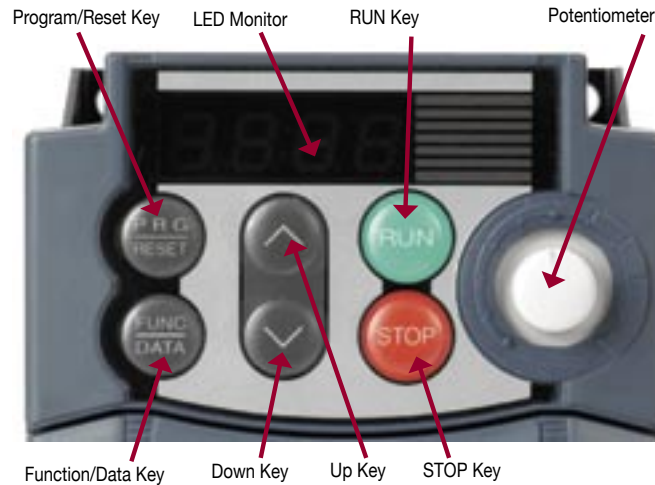

Table 3.1 Overview of Keypad Functions

Monitor, Potentiometer and Keys	Functions
	Four-digit, 7-segment LED monitor which displays the running status, data settings, and alarm status of the drive depending on the operation modes *. In Run mode, the monitor displays running status information (e.g. output frequency, current, and voltage). In Program mode, it displays menus, function codes and their data. In Alarm mode, it displays an alarm code which identifies the error factor if the protection facility is activated
	Potentiometer (POT) which is used to manually set frequency, auxiliary frequencies 1 and 2 or PID process command.
	RUN key. Press this key to run the motor.
	STOP key. Press this key to stop the motor.
	UP/DOWN keys. Press these keys to select the setting items and change the function data displayed on the LED monitor.
	Program/Reset key. Press this key to switch the operation modes* of the drive. Pressing this key in Run mode switches the drive to Program mode and vice versa. In Alarm mode, pressing this key after removing the error factor will switch the drive to Run mode.
	Function/Data key. Pressing this key in Run mode switches the information displayed (output frequency (Hz), current (Amps) or voltage (V)). Pressing this key in Program mode displays the function code and sets the data entered using the  /  keys or the POT. Pressing this key in Alarm mode displays information concerning the alarm code currently displayed on the LED monitor.

\* The AF-300 Mini features three operation modes – Running, Programming, and Alarm modes. Refer to Section 3.2, “Overview of Operation Modes.”

### Simultaneous keying

Simultaneous keying means depressing two keys at the same time (expressed by “+”). The AF-300 Mini supports simultaneous keying as listed below.

(For example, the expression “ + keys” stands for pressing the key while holding the key down.)

Operation modes	Simultaneous keying	Used to:
Run mode	+  keys	Control entry to/exit from jogging operation.
Program mode	+  keys	Change special function code data. (Refer to codes F00 and H03 in Chapter 5 “FUNCTION CODES.”)
Alarm mode	+  keys	Switch to Program mode.

### 3.2 Overview of Operation Modes

The AF-300 Mini features the following three operation modes:

- **Run mode:** This mode allows entering run/stop commands in regular operation. Running status may also be monitored in real time.
- **Program mode:** This mode allows checking function code data as well as a variety of other information relating to drive status and maintenance.
- **Alarm mode:** If an alarm occurs, the drive automatically enters Alarm mode. The corresponding alarm code\* and its related information are displayed on the LED display.

\* Alarm code: Shows the error factor that has activated the protection facility.  
For details, refer to Chapter 8, Section 8.6 “Protective Functions.”

Figure 3.1 shows the status transition of the drive between these three operation modes.

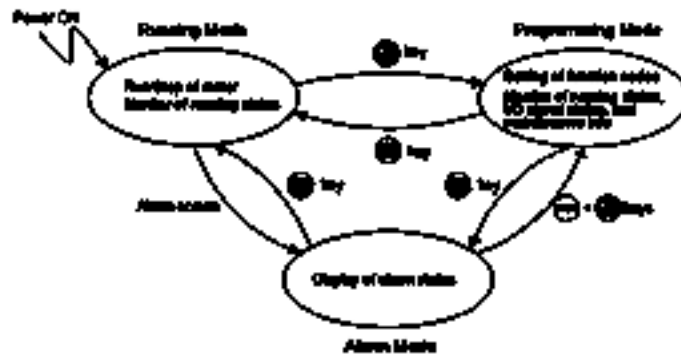

Figure 3.1 Status Transition between Operation Modes

#### 3.2.1 Run Mode

If the drive is turned on, it automatically enters Run mode in which you may:

- (1) Run/stop the motor
- (2) Set up the set frequency and others
- (3) Monitor the running status (e.g. output frequency, output current)
- (4) Jog (inch) the motor

REFERENCE: For details, refer to Section 3.3, “Operation in Run mode.”

### 3.2.2 Program Mode

Program mode provides various functions, such as setting and checking function code data, monitoring maintenance information and checking input/output (I/O) signal status. These functions can be easily selected with the menu-driven system. Table 3.2 lists menus available in Program mode. The leftmost digit (numeral) of each letter string indicates the corresponding menu number and the remaining three digits indicate the menu contents.

When the drive re-enters Program mode, the menu that was selected last in Program mode will be displayed.

#### Restricting menus to be displayed

In order to simplify operation, the menu-driven system has a special function (specified by function code E52) that restricts the menus to be displayed. The factory default is to display Menu #1 “Data setting” only, allowing no switching to any other menu.

Function Code E52 – Keypad (Mode Selection)

Function code data (E52)	Menus selectable
0: Function code data setting mode	Menu #1 “Data setting” (factory default)
1: Function code data check mode	Menu #2 “Data checking”
2: Full-menu mode	Menu #1 through #6 (#7*)

\* Menu #7 appears only when the remote keypad (option) is set up for use.



If the full-menu mode is selected, pressing the  or  key will cycle through menus. With the  key, you may select the desired menu. Once all of the menus have been cycled through, the display will return to the first menu.



Table 3.2 Menus Available in Program Mode

Menu	LED monitor shows:	Main functions	Refer to:
Menu #1 “Data setting”	1.F__	F codes (Fundamental functions)	Selecting each of these function codes enables its data to be displayed/changed.
	1.E__	E codes (Extension terminal functions)	
	1.C__	C codes (Control functions of frequency)	
	1.P__	P codes (Motor parameters)	
	1.H__	H codes (High performance functions)	
	1.J__	J codes (Application functions)	
	1.y__	y codes (Link functions)	
Menu #2 “Data checking”	2.rEP	Displays only function codes that have been changed from their factory defaults. You may refer to or change those function codes data.	Section 3.5
Menu #3 “Drive monitoring”	3.oPE	Displays the running information required for maintenance or test running.	Section 3.6
Menu #4 “I/O checking”	4.#_o	Displays external interface information.	Section 3.7
Menu #5 “Maintenance information”	5.CHE	Displays maintenance information including accumulated running time.	Section 3.9
Menu #6 “Alarm information”	6.AL	Displays the latest four alarm codes. You may refer to the running information at the time when the alarm occurred.	Section 3.9
Menu #7 “Data copying”	7.CPy	Allows you to read or write function code data, as well as verifying it. NOTE: To use this function, a remote keypad (option) is necessary.	



### 3.2.3 Alarm Mode

When the protection facility is activated to trigger an alarm, the drive automatically enters Alarm mode and the corresponding alarm code will appear in the LED display. Figure 3.2 shows the status transition of Alarm mode.

#### Releasing the Alarm and Transferring the Drive to Run Mode



Remove the cause of the alarm and press the  key to release the alarm and return to running status. The alarm can only be released using the  key once the alarm code is displayed.

#### Displaying the Alarm History

It is possible to display the most recent 3 alarm codes in addition to the one currently displayed. Previous alarm codes can be displayed by pressing the  key or the  key while the current alarm code is displayed.

#### Displaying the Running Information when an Alarm Occurs



If an alarm occurs, you may check various running status parameters (output frequency and output current, etc.) by pressing the  key when the alarm code is displayed. The item number and data for each running information is displayed alternately.

In addition, you can switch between the various running parameters using the  key or  key. Detailed running information is the same as for Menu #6 “Alarm information” in Program mode. Refer to Table 3.13 in Section 3.9 “Reading Alarm Information.”

Pressing the  key while the running information is displayed returns the display to the alarm codes.

NOTE: When the running information is displayed after removal of the alarm cause, pressing the  key a number of times in succession will cause the drive to shift the alarm code display and then release the alarm status. Be careful with a run command. If a run command has been entered at this stage, the motor will start running.

#### Switching to Program Mode

It is also possible to switch the drive to Program mode by pressing the  key +  key simultaneously while the alarm is displayed and then to check and adjust the function code data.

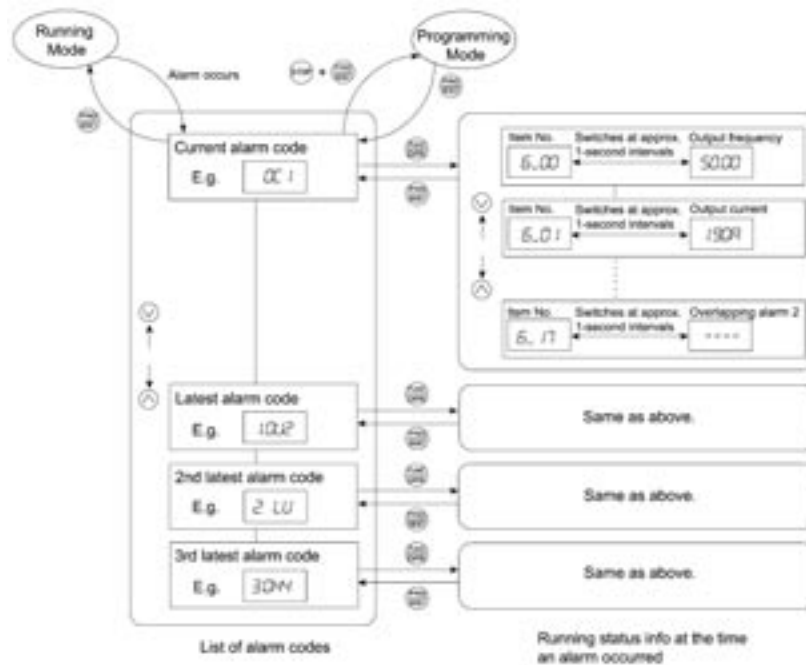





Figure 3.2 Alarm Mode Status Transition





### 3.3 Operation in Run Mode



If the drive is turned on, it automatically enters Run mode in which you may operate the following:

#### (1) Run/Stop the Motor

By factory default, pressing the  key starts running the motor in the forward direction and pressing the  key decelerates the motor to stop. The  key is enabled only in Run mode.

Changing function code F02 data makes it possible to run the motor in the reverse direction by pressing the , determine the motor rotation direction by entering input signals to the terminals, and control the motor by pressing the /  keys.



#### (2) Set up the Set Frequency and Others





By using the potentiometer and /  keys on the keypad, you may set up the desired set frequency and PID process commands. It is also possible to set up the set frequency as frequency, load shaft speed, line speed, and constant feeding rate time by setting function code E48.

##### Setting up the set frequency with the potentiometer on the keypad (factory default)



If you set function code F01 data to “4: Potentiometer on the keypad” (factory default) and select frequency command-1 with function codes E01 through E03 (Hz2/Hz1 = OFF), the potentiometer is then enabled to choose the set frequency. Setting function code C30 to “4: Potentiometer on the keypad” and selecting frequency command-2 (Hz2/Hz1 = ON) also produce the same effect.

Setting up the set frequency with the  and  keys

If you set function code F01 data to “0: Keypad operation” and select frequency command-1, then the /  keys are enabled to set up the set frequency in Run mode. In any other operation modes, those keys remain disabled.



Pressing the /  key calls up the set frequency with the lowest digit flashing. Pressing the /  key again makes it possible to change the set frequency. The new setting will be saved internally. Even if the drive is switched to some other frequency entry and then returned to the keypad entry, the setting will be retained.

Even turning off the drive will automatically save the setting into the non-volatile memory. The next time the drive is turned on, the setting will become the default frequency.

If you set function code F01 data to “0: Keypad operation” but do not select frequency command-1, then the /  keys cannot be used for setting up the set frequency. Pressing those keys will just display the currently selected set frequency.





Setting up the frequency from any other displayed item depends on function code E48 data (= 4, 5, or 6) “LED monitor details (Select speed monitor)” as listed in the following table.

E48 data “LED monitor details (Select speed monitor)”	Set frequency display	Conversion of displayed value
0: Output frequency (before slip compensation)	Frequency command	
1: Output frequency (after slip compensation)	Frequency command	
2: Set frequency	Frequency command	
4: Load shaft speed	Load shaft speed setting	Frequency command x E50
5: Line speed	Line speed setting	Frequency command x E50
6: Constant feeding rate time	Constant feed rate time setting	E50/frequency setting x E39

If you set function code C30 data to “0: Keypad operation” and select frequency command-2, then the /  keys are enabled to select the set frequency.

### Make setting under PID control

To enable PID control, you need to set function control code J01 data to 1 or 2.



Under the PID control, the items that can be set or checked with the / keys are different from those under regular frequency control, depending upon the current LED monitor setting. If the LED monitor is set to the speed monitor (E43 = 0), you may access manual feed commands (Set frequency) with the / keys; if it is set to any other, you may access PID process commands with those keys.





REFERENCE: Refer to User's Manual, Chapter 4, Section 4.8 "PID Frequency Command Generator" for details on the PID control.

### Setting the PID process command with the built-in potentiometer

Set function code E60 data to "3: PID process command" and J02 to "1: PID process command." After that, selecting PID control remote process command enables you to set the PID process command using the built-in potentiometer.



### Setting the PID process command with the and keys

Set function code J02 data to "0: Keypad operation" and set the LED monitor to the setting other than the speed monitor (E43 = 0) in Run mode. This makes it possible to set the PID process command using the  and  keys. This setting is possible only in Run mode.

Pressing the  or  key displays the PID process command with the lowest digit flashing on the LED monitor. Pressing the  or  key again makes it possible to change the PID process command. Once the PID process command is modified, it will be saved internally. Even if the drive is switched to another PID process command entry and then returned to the keypad entry, the setting will be retained.

Turning off the drive will automatically save the setting into the non-volatile memory. The next time the drive is turned on, the setting will become the default PID process command.

Even if the PID process command is selected ((SS4) = ON) in the multistep frequency, it is still possible to set the process command using the keypad.

When function code J02 data has been set to any value except 0, pressing the  or  key displays the PID process command currently selected (setting is not possible).

When the PID process command is displayed, the decimal point next to the lowest digit on the LED display flashes to discriminate it from the regular frequency command.





### Setting up the set frequency with the and keys under the PID control



To set the set frequency with the  and  keys under the PID control, you need to specify the following conditions:

- Set function code F01 data to "0: Keypad operation."
- Select frequency command-1 (Frequency commands from communications link: Disabled, and Multistep frequency commands: Disabled) as manual speed command.
- Set the LED monitor to the speed monitor in Run mode.



The above setting is impossible in any operation mode except Run mode.

The setting procedure is the same as that for the frequency command.

If you press the  or  key in any conditions other than those described above, the following will appear:

Frequency command 1 (F01)	Frequency command from communications link	Multistep frequency command	PID control cancelled	Displayed using  or  key
0	Disabled	Disabled	PID enabled	Frequency command by keypad
			Cancelled	
Other than the above			PID enabled	PID output (as final frequency command)
			Cancelled	Manual speed command currently selected (frequency command)

TIP:

- When setting the frequency and others with the / keys, the lowest digit on the display will flash. Change the setting, starting from the lowest digit and the cursor will move to the next digit to be changed.
- When the data is to be dump-changed, hold down the  key for 1 second or longer, and the flashing cursor will move to the next digit where the data can be changed (cursor movement).

### (3) Monitor the Running Status

In Run mode, the seven items listed below can be monitored. Immediately after the drive is turned on, the monitor item specified by function code E43 is displayed. Press the  key to switch between monitor items.

Table 3.3 Monitor Items

Monitor Items	Display Sample on the LED monitor	Meaning of Displayed Value
Speed monitor (Hz, rpm, m/min, min)	50.00	Refer to Table 3.4.
Output current (A)	1.90A	Detected value
Power (kW)	0.40P	P: An alternative expression for kW
Output voltage (V)	200U	Commanded value
PID process command (Note)	10.00	(PID process command or PID feedback amount) × (factor A – B) + B PID factors A and B: Refer to function codes E40 and E41
PID feedback amount (Note)	9.00	
Timer (sec) (Note)	6	Remaining effective timer count

NOTE: The PID process command and PID feedback amount are displayed only under the PID control using a process command (J01 = 1 or 2). The timer (for timer operation) is only displayed when timer is enabled (C21 = 1). Figure 3.3 shows the procedure for selecting the desired monitor item.

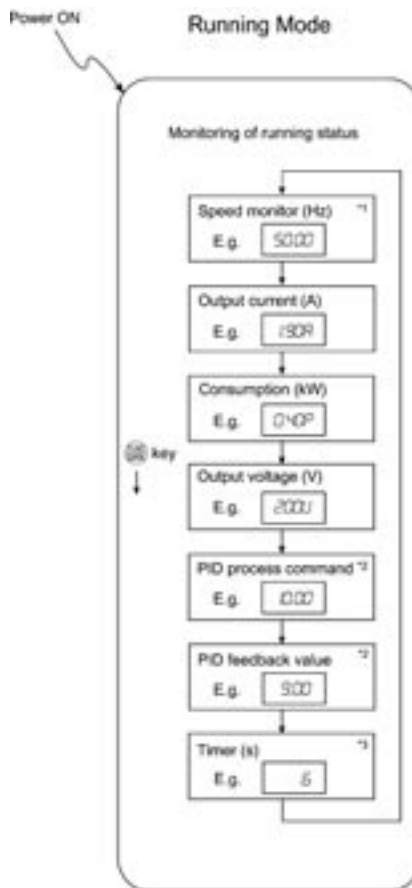

Figure 3.3 Monitor Item Selection Example

\*1 The speed monitor can display the output frequency (Hz), set frequency (Hz), load shaft speed (rpm), line speed (m/min.), and constant feeding rate time (min.) which can be selected by with function code E48.

\*2 This PID-related information will appear only when the drive is under the PID control. (Refer to Section 3.3.)

\*3 This will appear only when timer operation is enabled by setting up function code C21. (Refer to Chapter 5.)

Table 3.2 lists the display items for the speed monitor that can be chosen with function code E48.

Table 3.2 Display Items on the Speed Monitor

Speed monitor items	Function code E48 data	Meaning of Displayed Value
Output frequency (before slip compensation) (Hz) (Factory default)	0	Before slip compensation frequency
Output frequency (after slip compensation) (Hz)	1	Frequency actually being output
Set frequency (Hz)	2	Final set frequency
Load shaft speed (rpm)	4	Display value = Output frequency (Hz) x E50*
Line speed (m/min)	5	Display value = Output frequency (Hz) x E50*
Constant feeding rate time (min)	6	Display value = * E50/Output frequency x E39

\* Output frequencies contained in these formulas are output frequencies before slip compensation.

#### (4) Jog (Inch) the Motor

In Run mode, pressing the + keys at the same time (simultaneous keying) can make the drive ready for jogging. The JoG appears on the LED monitor.

To return the drive from the ready-to-jog state to the usual running state, press the + keys simultaneously.

Using the external input signal command (JOG) also allows the transition between the ready-to-jog state and usual running state.

REFERENCE: Refer to function codes E01 to E03 in Chapter 5 for details.

During jogging, the jogging frequency (C20) and acceleration/deceleration time for jogging (H54) will apply. They are exclusively prepared for jogging and required to be set up individually.

When jogging the motor from the keypad, the drive will only run while the key is held down, and contrarily the moment the key is released, the drive will decelerate and stop the motor.

NOTE: The transition ( + keys) between the ready-to-jog state and usual running state is enabled only when the drive is at a halt.

### 3.4 Setting the Function Codes – “Data setting”

Menu #1 “Data setting” in Program mode allows you to set function codes for making the drive functions match your needs.

The table below lists the function codes available in the AF-300 Mini. The function codes are displayed on the LED monitor on the keypad as shown below.

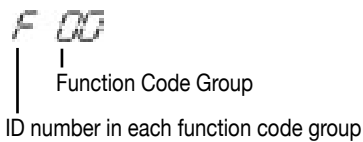

Table 3.5 List of AF-300 Mini Function Codes

Function code group	Function code	Function	Description
F codes (Fundamental functions)	F00 to F51	Basic functions	To be used for basic motor running.
E codes (Extension terminal functions)	E01 to E99	Terminal functions	To be used to select the functions of the control circuit terminals. To be used to set functions related to the LED monitor display.
C codes (Control functions of frequency)	C01 to C52	Frequency control functions	To be used to set application functions related to frequency commands.
P codes (Motor parameters)	P02 to P99	Motor parameters	To be used to set special parameters for the motor capacity, etc.
H codes (High performance functions)	H03 to H98	High level functions	To be used for high added value functions and complicated control, etc.
J codes (Application functions)	J01 to J06	Application functions	To be used for PID control.
y codes (Link functions)	y01 to y99	Link functions	To be used for communications

REFERENCE: Refer to Chapter 5 “FUNCTION CODES” for details on the function codes.

#### Function codes that require simultaneous keying

To change data for function codes F00 (Protect data) and H03 (Initialize data), simultaneous keying operation is necessary-- + keys or + keys. This prevents data from being lost by mistake.

## Changing, reflecting, and saving of function code data during running

Some function code data can be changed while the motor is running and some can not. Further, amongst the function codes whose data can be changed while the motor is running, there are some for which the changes can be reflected immediately and others for which that is not possible. Refer to the “Changes during running” column in Chapter 5, Section 5.1 “Function Code Tables.”

Figure 3.4 shows the status transition for Menu #1 “Data settings” and Figure 3.5 shows an example of the function code data changing procedure.

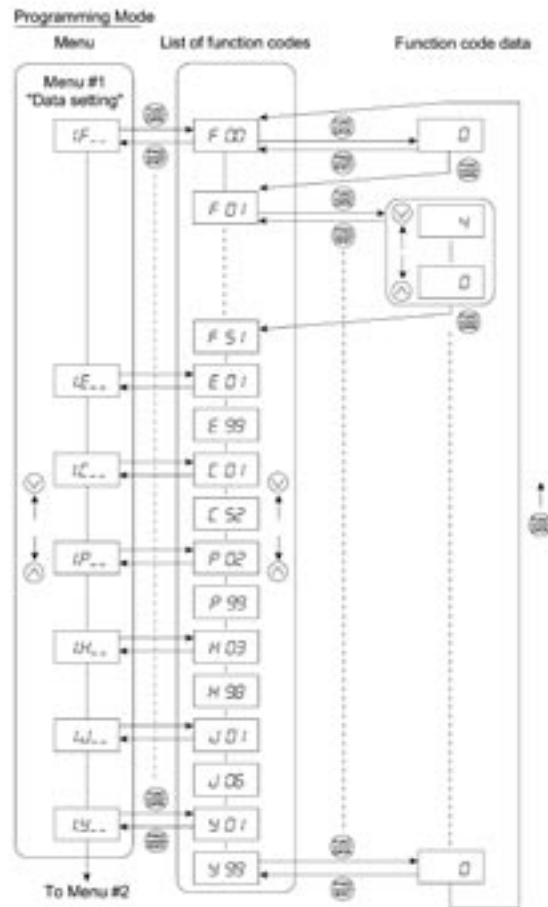







\* Press the  key when the y99 data is displayed to return to F00.



Figure 3.4 Status Transition Diagram for “Data Setting”

## Basic key operation

This section will give a description of the basic key operation, following the example of the function code data changing procedure shown in Figure 3.5.

This example shows you how to change function code F01 data from the factory default of “Potentiometer operation on the keypad (F01 = 4)” to “/ key operation (F01 = 0).”

- (1) With the menu displayed, use the  and  keys to select the desired function code group. (In this example, select 1.F\_ ).
- (2) Press the  key to display the function codes in the function code group selected in (1). (In this example, function code F00 will appear.)

Even if the function code list for a particular function code group is displayed, it is possible to transfer the display to a different function code group using the / keys.

- (3) Select the desired function code using the and keys and press the key. (In this example, select function code F01.)

The data for this function code will appear. (In this example, data 4 of F01 will appear.)

- (4) Change the function code data using the and keys. (In this example, press the key four times to change data 4 to 0.)

- (5) Press the key to establish the function code data.

SAUE will appear on the display and the data will be saved into non-volatile memory. The display will return to the function code list, then move to the next function code. (In this example, F02.)

Pressing the key before the key cancels the change made to the data. The data reverts to the previous value, the display returns to the function code list, and the original function code reappears.

- (6) Press the key to return to the menu from the function code list.

TIP: Cursor movement: You may move the cursor when changing function code data in the same way as with the frequency commands. Refer to Subsection 3.3 (2) “Setting the Set Frequency and Others.”

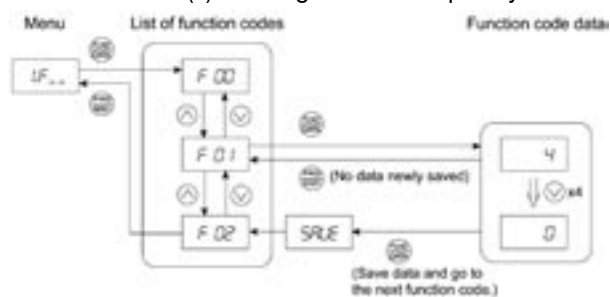
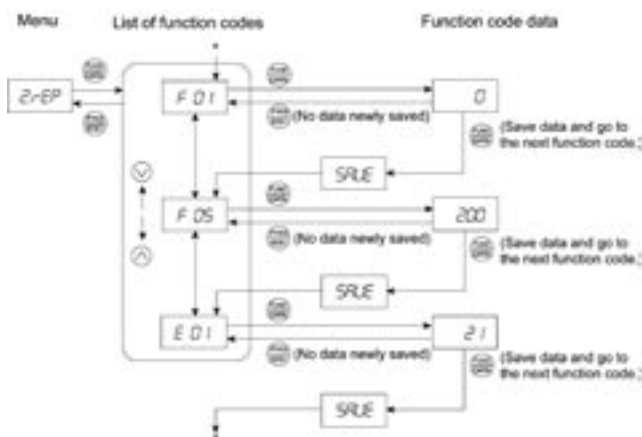

Figure 3.5 Example of Function Code Data Changing Procedure

### 3.5 Checking Changed Function Codes – “Data checking”

Menu #2 “Data checking” in Program mode allows you to check function codes that have been changed. Only data that has been changed from the factory defaults are displayed on the LED monitor. You may refer to the function code data and change again if necessary. Figure 3.6 shows the status transition diagram for “Data checking.”



\* Press the key when the E01 data is displayed to return to F01.

Figure 3.6 Data Checking Status Transition Diagram (Changes made only to F01, F05, E01)

#### Basic key operation

The basic key operation is the same as for Menu #2 “Data setting.”

### 3.6 Monitoring the Running Status – “Drive monitoring”

Menu #3 “drive monitoring” is used to check the running status during maintenance and test running. The display items for “drive monitoring” are listed in Table 3.5. Using keys, you may check those items in succession. Figure 3.7 shows the status transition diagram for “drive monitoring.”

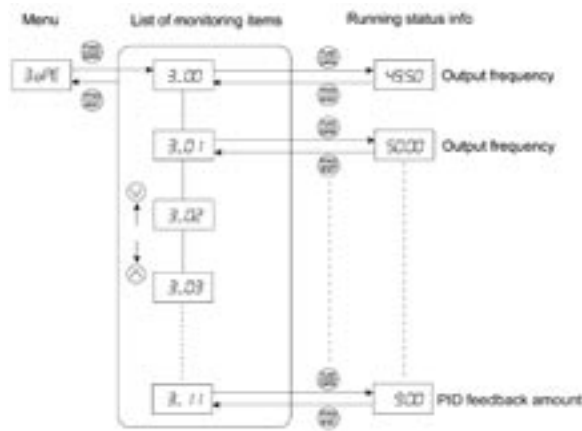

Figure 3.7 Drive Monitoring Status Transition

#### Basic key operation

- (1) With the menu displayed, use the and keys to select “drive monitoring” (3.oPE).
- (2) Press the key to display the desired code in the monitoring items list (e.g. 3\_00).
- (3) Use the and keys to select the desired monitoring item, then press the key. The running status information for the selected item will appear.
- (4) Press the key to return to the monitoring items list. Press the key again to return to the menu.

Table 3.6 Drive Monitoring Display Items

LED monitor display	Contents	Unit	Description
3_00	Output frequency	Hz	Output frequency before slip compensation
3_01	Output frequency	Hz	Output frequency after slip compensation
3_02	Output current	A	Current output current
3_03	Output voltage	V	Current output voltage
3_05	Set frequency	Hz	Current set frequency
3_06	Running direction	N/A	Displays the running direction currently being outputted. F: forward; R: reverse, ----: stop
3_07	Running status	N/A	Displays the running status in hex. format. Refer to “Displaying running status” on the next page.
3_09	Load shaft speed (line speed)	rpm (m/min)	The unit for load shaft speed is rpm and that for line speed is m/min. Display value = (Output frequency Hz before slip compensation) × (Function code E50) □□□□ is displayed for 10000 (rpm or m/min) or more. When □□□□ is displayed, the data is overflowing, which means that the function code should be reviewed. For example: Load shaft speed = Displayed data × 10 (rpm)
3_10	PID process commands	N/A	These commands are displayed through the use of function code E40 and E41 data (PID factors A and B). Display value = (PID process command) × (Factor A - B) + B If PID control is disabled, “----” appears.
3_11	PID feedback amount	N/A	This value is displayed through the use of function code E40 data and function code E41 data (PID factors A and B). Display value = (PID feedback amount) × (Factor A - B) + B If PID control is disabled, “----” appears.



## Displaying running status

To display the running status in hexadecimal format, each state has been assigned to bit 0 to 15 as listed in Table 3.6. Table 3.7 shows the relationship between each of the status assignments and the LED monitor display. Table 3.8 gives the conversion table from 4-bit binary to hexadecimal.

Table 3.7 Running Status Bit Allocation

Bit	Notation	Content
15	BUSY	1 when function code data is being written
14	WR	Always 0
13		Always 0
12	RL	1 when communications is effective (when running commands and set frequency commands are issued via communications)
11	ALM	1 when an alarm has occurred
10	DEC	1 during deceleration
9	ACC	1 during acceleration
8	IL	1 during current limitation
7	VL	1 under voltage control
6	TL	Always 0
5	NUV	1 when intermediate dc voltage has increased up to the specified level (0 when the voltage is too low)
4	BRK	Always 0
3	INT	1 when the drive output is shut down
2	EXT	1 during dc braking
1	REV	1 during running in the reverse direction
0	FWD	1 during running in the forward direction

Table 3.8 Running Status Display

LED No.	LED4				LED3				LED2				LED1			
	15	14	13	12	11	10	9	8	7	6	5	4	3	2	1	0
Bit	15	14	13	12	11	10	9	8	7	6	5	4	3	2	1	0
Notation	BUSY	WR	RL	ALM	DEC	ACC	IL	VL	TL	NUV	BRK	INT	EXT	REV	FWD	
Display	0 - F				0 - F				0 - F				0 - F			
Input example (binary)	1	0	0	0	0	0	1	1	0	0	1	0	0	0	0	1
On the LED monitor	8				3				2				1			



### Hexadecimal expression

A 16-bit binary number is expressed in hexadecimal format (4 digits). Table 3.8 shows the expression. The hexadecimals are shown as they appear on the LED monitor.

Table 3.9 Binary and Hexadecimal conversion

Binary				Hexadecimal	Binary				Hexadecimal
0	0	0	0	0	1	0	0	0	8
0	0	0	1	1	1	0	0	1	9
0	0	1	0	2	1	0	1	0	A
0	0	1	1	3	1	0	1	1	b
0	1	0	0	4	1	1	0	0	C
0	1	0	1	5	1	1	0	1	d
0	1	1	0	6	1	1	1	0	E
0	1	1	1	7	1	1	1	1	F

### 3.7 Checking I/O Signal Status – “I/O checking”

With Menu #4 “I/O checking,” you may display the I/O status of external signals without using a measuring instrument. External signals that can be displayed include digital I/O signals and analog I/O signals. Table 3.9 lists check items available. The status transition for I/O checking is shown in Figure 3.8.

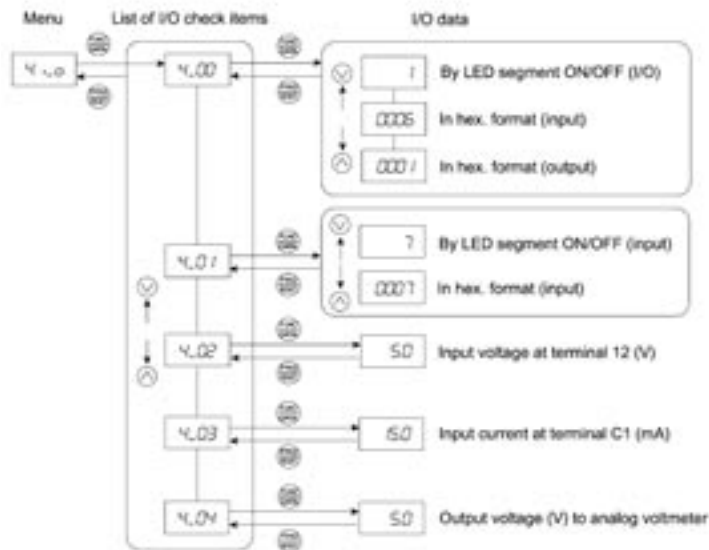

Figure 3.8 Status Transition of I/O Check

#### Basic key operation

- (1) With the menu displayed, use the and keys to select “I/O check”(4\_r\_o).
- (2) Press the key to display the codes for the I/O check item list. (e.g. 4\_00)
- (3) Use the and keys to select the desired I/O check item, then press the key.

The corresponding I/O check data will appear. For control I/O signal terminal and control circuit terminal input under communication control, use the and keys to select one of the two different display methods.

- (4) Press the key to return to the I/O check item list. Press the key again to return to the menu.

Table 3.10 I/O Check Items

LED monitor display	Display contents	Description
4_00	I/O signals on the control circuit terminals	Shows the ON/OFF state of the digital I/O terminals. Refer to “Displaying control I/O signal terminals” below for details on the display contents.
4_01	I/O signals on the control circuit terminals when communications control {LE} is active	Shows the ON/OFF state for the digital input terminals that received a command via RS485 communications. Refer to “Displaying control I/O signal terminals” below for details on the display contents.
4_02	Input voltage on terminal [12]	Shows the input voltage on terminal [12] in volts (V).
4_03	Input current on terminal [C1]	Shows the input current on terminal [C1] in milliamperes (mA).
4_04	Output voltage to analog meters [FMA]	Shows the output voltage on terminal [FMA] in volts (V).

**Displaying control I/O signal terminals**

The status of control I/O signal terminal status may be displayed with ON/OFF of the LED segment or in hexadecimal display.

■ Display I/O signal status with ON/OFF of the LED Segment

As shown in Table 3.10 and the figure below, segments “a” to “e” on LED1 light when the digital input terminals ([FWD], [REV], [X1], [X2], and [X3]) are short-circuited with the terminal [CM] (ON) and do not light when they are opened (OFF). Segment “a” on LED3 lights when the circuit between output terminal [Y1] and terminal [Y1E] is closed (ON) and does not light when the circuit is open (OFF). LED4 is for terminals [30A], [30B], [30C]. Segment “a” on LED4 lights when the circuit between terminals [30C] and [30A] are short-circuited (ON) and does not light when they are opened.

NOTE: This LED monitor displays hardware terminal information, which means that it may not light when it is in negative logic (refer to Chapter 5 “FUNCTION CODES” for details), even when it is active.

Table 3.10 Segment Display for External Signal Information



Segment	LED4	LED3	LED2	LED1
a	30A-30C	Y1-Y1E	—	FWD-CM
b	—	—	—	REV-CM
c	—	—	—	X1-CM
d	—	—	—	X2-CM
e	—	—	—	X3-CM
f	—	—	(XF)	—
g	—	—	(XR)	—
dp	—	—	(RST)	—

—: No correlating control circuit terminals.

\* (XF) and (XR) are assigned for communication. Refer to “Displaying control I/O signal terminal block under communication control.”

**Displaying I/O signal status in hexadecimal format**

Each I/O terminal is assigned to bit 15 through bit 0 as listed in Table 3.11. An unassigned bit is interpreted as “0.” Allocated bit data is displayed on the LED monitor in 4-digit hexadecimals (“0” to “F” each).

In the AF-300 Mini, digital input terminals [FWD] and [REV] are assigned to bit 0 and bit 1, respectively. Terminals [X1] through [X3] are assigned to bits 2 through 4. The value “1” is set for each bit when the assigned input terminal is short-circuited with terminal [CM] (ON). The value “0” when it opens (OFF). For example, when [FWD] and [X1] are ON and all others are OFF, the display on LED4 to LED1 would be 0005.

The value “1” is set when bit 0 is assigned to digital output terminal [Y1] and the terminal is short-circuited with [Y1E], and the value “0” is set when it opens. The status of the mechanical relay contact output terminal [30A], [30B]

and [30C] are assigned to bit 8. The value “1” is set when the circuit between output terminals [30A] and [30C] is closed and the value “0” when the circuit between [30B] and [30C] is closed. For example, if [Y1] is ON and the circuit between [30A] and [30C] are short-circuited with each other, then the display for LED4 to LED1 would be 0101. How the hexadecimal display is configured for the terminals to which bits 15 to 0 are assigned and the 7-segment LED is shown below.

LED No.	LED4				LED3				LED2				LED1			
Bit	15	14	13	12	11	10	9	8	7	6	5	4	3	2	1	0
Input terminal	(RST)	(XR)	(XF)	-	-	-	-	-	-	-	-	X3	X2	X1	REV	FWD
Output terminal	-	-	-	-	-	-	-	30ABC	-	-	-	-	-	-	-	Y1
E.g. of input (binary)	0	0	0	0	0	0	0	0	0	0	0	0	0	1	0	1
LED monitor display (hexadecimal)	0				0				0				5			

- : no correlating control connector

\* (RST), (XF) and (XR) are assigned for communication. Refer to “Displaying control I/O signal terminal block under communication control.”

Figure 3.9 Segment Display for I/O Signal Status in Hexadecimal Format

### Displaying control I/O signal terminal block under communication control

There are two control circuit input displays under communications link control – “display with ON/OFF of the LED segment” and “in hexadecimal format” for input commanded from RS485 communications link. The content is similar to that of the control I/O signal terminal status display; however, (XF) and (XR) are added as inputs and nothing is assigned as output terminals.

REFERENCE: Refer to the user’s manual of RS485 communication for details on input by commands sent through RS485 communications.

### 3.8 Reading Maintenance Information--“Maintenance information”

Menu #5 “Maintenance information” in Program mode contains information necessary for performing maintenance on the drive. Table 3.12 lists the maintenance information display items and Figure 3.9 shows the status transition for maintenance information.

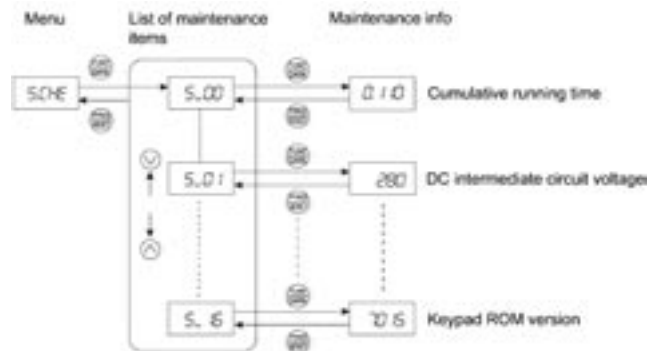

Figure 3.9 Status Transition of Maintenance Information Monitoring

#### Basic key operations

- (1) With the menu displayed, use the and keys to select “Maintenance information” (5.CHE).
- (2) Press the key to display the list of maintenance item codes (e.g. 5\_00).
- (3) Use the and keys to select the desired maintenance item, then press the key.  
The data of the corresponding maintenance item will appear.
- (4) Press the key to return to the list of maintenance items. Press the key again to return to the menu.

Table 3.12 Maintenance Display Items

LED Monitor Display	Display contents	Description
5_00	Accumulated running time	Shows the accumulated power-on time of the drive. Unit: thousands of hours. When the total ontime is less than 10,000 hours (display: 0.001 to 9.999), it is possible to check data in hourly units. When the total time is 10,000 hours or more (display: 10.00 to 65.53), the display will change to units of 10 hours. When the total time exceeds 65,535 hours, the display will be reset to 0 and the count will start again.
5_01	DC voltage at intermediate circuit	Shows the dc voltage at main intermediate circuit of the drive. Unit: V (volts)
5_03	Max. temperature of heat sink	Shows the maximum temperature of the heat sink for every hour. Unit: °C
5_04	Max. effective current	Shows the maximum effective current for every hour. Unit: A (amperes)
5_05	Capacity of the intermediate dc circuit capacitor	Shows the factory default for capacity of the intermediate dc circuit capacitor as 100%. Refer to Chapter 7 "MAINTENANCE AND INSPECTION" for details. Unit: %
5_06	Accumulated running time of electrolytic capacitor on the printed circuit board/s	Shows the total use time for the capacitor mounted on the printed circuit board/s. The display method is the same as for "accumulated run time." However, when the total time exceeds 65,535 hours, the count stops and the display remains at 65.53.
5_07	Accumulated run time of the cooling fan	Shows the accumulated operating time of the cooling fan. The cooling fan ON/OFF control (function code H06) is effective, so the time when the fan is stopped is not counted. The display method is the same as for "accumulated run time." However, when the total time exceeds 65,535 hours, the count stops and the display remains at 65.53.
5_08	Number of startups	The motor run times (the number of times the drive running command is set to ON) are calculated and displayed. 1.000 indicates 1,000 times. When any number ranging from 0.001 to 9.999 is displayed, the display increases by 0.001 per startup, and when any number from 10.00 to 65.53 is displayed, the display increases by 0.01 every 10 startups.
5_11	Number of RS485 errors	Shows the total number of times and RS485 communications error has occurred after the power is turned on. Once the number of errors exceeds 9.999, the display (count) returns to 0.
5_12	RS485 error contents	Shows the latest error that has occurred with RS485 communications in hexadecimal format. Refer to the user's manual of RS485 communication.
5_14	ROM version of drive	Shows the ROM version of the drive as a 4-digit display.
5_16	ROM version of keypad panel	Shows the ROM version of the keypad panel as a 4-digit display. (For remote keypad only.)

### 3.9 Reading Alarm Information – “Alarm information”

Menu #6 [Alarm information] in Program mode shows the cause of the past 4 alarms as alarm codes. Further, it is also possible to display alarm information that indicates the status of the drive when the alarm occurred. Table 3.13 shows the contents of the alarm information and Figure 3.10 shows the status transition of the alarm information.

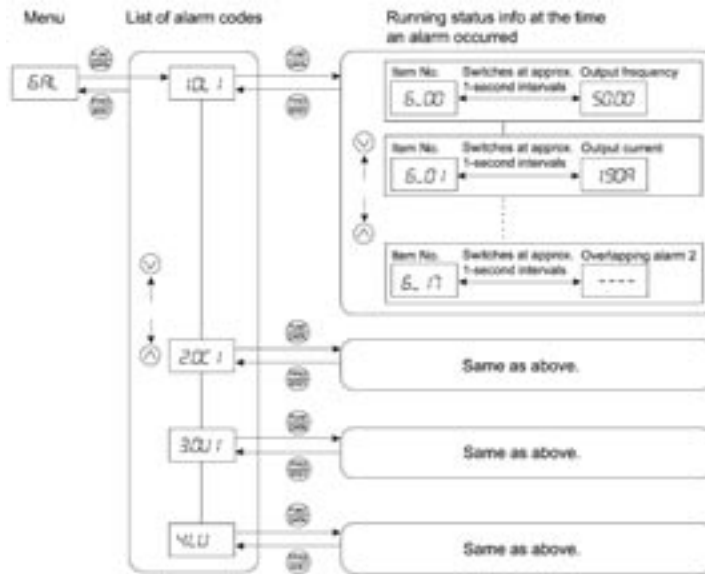

Figure 3.10 Status Transition of Alarm Information

#### Basic key operations

- (1) With the menu displayed, use the and keys to select “Alarm information” (6.AL).
- (2) Press the key to display the alarm list code (e.g. 1.0L1).  
In the list of alarm codes, the alarm information for last 4 alarms will be saved as an alarm history.
- (3) Each time the and keys are pressed, the last four alarms are displayed in order from the most recent one as “1”, “2”, “3” and “4”.
- (4) Press the key while the alarm code is displayed, and the corresponding alarm item number (e.g. 6\_00) and data (e.g. Output frequency) are displayed continuously in turn for 1 second each. It is possible to display the item number (e.g. 6\_01) and data (e.g. Output current) for each desired alarm using the and keys.
- (5) Press the key to return to the alarm list. Press the key again to return to the menu.

Table 3.13 Alarm Information Contents

LED monitor display (item No.)	Display contents	Description
6_00	Output frequency	Output frequency before slip compensation
6_01	Output current	Current output current
6_02	Output voltage	Current output voltage
6_04	Set frequency	Current set frequencies
6_05	Run direction	This shows the running direction being output. F: normal; R: reverse; - - -: stop
6_06	Running status	This shows the running status as a hexadecimal display. Refer to Displaying running status in Section 3.6 "Monitoring the Running Status."
6_07	Accumulated running time	Shows the accumulated power-on time of the drive. Unit: thousands of hours. When the total ontime is less than 10,000 hours (display: 0.001 to 9.999), it is possible to check data in hourly units. When the total time is 10,000 hours or more (display: 10.00 to 65.53), the display will change to units of 10 hours. When the total time exceeds 65,535 hours, the display returns to 0 and the count is started again.
6_08	Number of startups	The motor run times (the number of times the drive running command is set to ON) are calculated and displayed. 1.000 indicates 1,000 times. When any number from 0.001 to 9.999 is displayed, the display increases by 0.001 per startup, and when any number from 10.00 to 65.53 is displayed, the display increases by 0.01 every 10 startups.
6_09	Intermediate dc circuit voltage	Shows the voltage of the intermediate dc circuit of the drive's main circuit. Unit: V (volts)
6_11	Max. temperature of heat sink	Shows the maximum temperature of the heat sink. Unit: °C
6_12	Terminal I/O signal status (displayed with the ON/OFF of LED segments)	Shows the ON/OFF status of the digital I/O terminals. Refer to "Displaying control I/O signal terminals" in Section 3.7 "Checking I/O Signal Status" for details.
6_13	Signal input terminal status (in hexadecimal format)	
6_14	Terminal output signal status (in hexadecimal display)	
6_15	Number of consecutive occurrences	This is the number of times the same alarm occurs consecutively.
6_16	Overlapping alarm 1	Simultaneously occurring alarm codes (1) (- - - - is displayed if no alarms have occurred.)
6_17	Overlapping alarm 2	Simultaneously occurring alarm codes (2) (- - - - is displayed if no alarms have occurred.)

NOTE: When the same alarm occurs a number of times in succession, the alarm information from the first time is retained and the information for the following alarms is not updated.

# ***Notes***



## 4. Running the Motor

### 4.1 Running the motor for a test

#### 4.1.1 Inspection and Preparation Prior to Operation

Check the following prior to starting operation.

- (1) Verify correct connection.

Carefully verify that the motor power cables are connected to drive output terminals U, V and W and that the ground cable is connected to the ground electrode correctly.

#### WARNING

- Do not connect power supply wires to the drive output terminals U, V, and W. Otherwise, the drive may be damaged if you turn the power on.
- Be sure to connect the ground leads of the drive and the motor to the ground electrodes.

**Otherwise, electric shock may occur.**

- (2) Check for short circuits between terminals and exposed live parts and ground faults.
- (3) Check for loose terminals, connectors and screws.
- (4) Check if the motor is not connected to a driven load.
- (5) Turn all switches off so that the drive does not start or operate erroneously at power-on.
- (6) Check that safety measures have been taken against runaway of the system, e.g. a defense to protect people from unexpectedly approaching your power system.

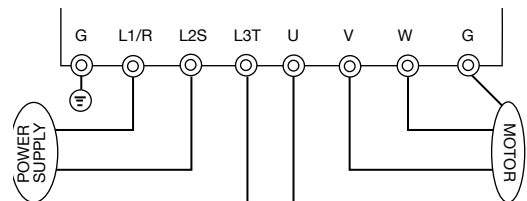

Figure 4.1 Drive connection diagram

#### 4.1.2 Turning on Power and Checking

#### WARNING

- Be sure to install the terminal cover before turning the power on. Do not remove the cover while power is turned on.
- Do not operate switches with wet hands.

**Otherwise electric shock could occur.**

Turn the power on and check the following points.

This example shows when no function code data is changed from the factory setting.

- (1) Check that the LED monitor displays “0.00” (meaning that the set frequency is 0 Hz) and is flashing. (See Figure 4.2)  
If the LED monitor displays numbers other than “0.00,” turn the potentiometer to set “0.00” as the set frequency.
- (2) Check that any built-in cooling fan is functioning normally (for models with 2 hp and above).



Figure 4.2 Display of the LED Monitor after Power-on

#### 4.1.3 Preparation before Running the Motor for a Test – Setting Function Code Data

Before initial running of the motor, set the function code data specified in Table 4.1 to the corresponding motor rating and for your system design values. For motor information, check the rated values printed on the nameplate of the motor. For your system design values, check with the system designers.

REFERENCE: For details about how to set function code data, refer to Chapter 3, Section 3.4 “Setting the Function Codes.”

Table 4.1 Settings of Function Code Data before Driving the Motor for a Test

Function code	Name	Function code data	Factory setting
F04	Base frequency	Motor ratings (printed on the nameplate of the motor)	60.0 (Hz)
F05	Rated Voltage (at base frequency)		230V/460V (Output voltage interlocked with the source voltage)
P02	Motor Parameter (Rated capacity)		Applicable motor rating capacity
P03	Motor Parameter (Rated current)		Rated current of applicable motor rating
F03	Maximum frequency	System design values	60.0 (Hz)
F07	Acceleration time *	* To test-drive of the motor, increase values so that they are longer than your system design values. If the set time is short, the drive may not start running the motor.	6.00 (sec)
F08	Deceleration time *		6.00 (sec)

#### 4.1.4 Test run

### WARNING

If the user set the function codes wrongly or without completely understanding this Instruction Manual and the AF-300 Mini User’s Manual, the motor may rotate with torque or speed not permitted for the machine.



#### Accident or injury may result.

First follow the instructions of the subsections 4.1.1, “Inspection and Preparation Prior to Operation” and 4.1.3, “Preparation Prior to Running the Motor for a Test,” then begin test-running the motor.

### CAUTION

If any abnormality is found to the drive or motor, immediately stop operation and determine the cause referring to Chapter 6, “TROUBLESHOOTING.”

#### Procedure for Test Run

- (1) Turn the power on and check that the LED monitor flashes while indicating the 0.00 Hz frequency.
- (2) Rotate the built-in potentiometer clockwise, set the frequency to a low frequency such as 5 Hz. (Check that set frequency flashes on the LED monitor.)
- (3) Press the  key to start running the motor in the forward direction. (Check that the set frequency is displayed on the LED monitor correctly.)
- (4) To stop the motor, press the  key.

#### Check the following points

- Check if the direction of rotation is correct.
- Check for smooth rotation without motor humming or excessive vibration.
- Check for smooth acceleration and deceleration.

If no abnormality is found, turn the potentiometer clockwise to raise the set frequency. Check the above points for the test-driving of the motor.

### 4.2 Operation

After checking that the operations finished correctly through the above test-driving, start normal operation.

## 5. Function Codes







### 5.1 Function Code Tables

Function codes enable the AF-300 Mini series of drives to be set up to match your system requirements.

Each function code consists of a 3-character string. The first is a letter identifying the group and the following two are numerals that defining each individual code in the group. Function codes are classified into seven groups: Fundamental Functions (F codes), Extension Terminal Functions (E codes), Control Functions of Frequency (C codes), Motor Parameters (P codes), High Performance Functions (H codes), Application Functions (J codes), and Link Function (y codes). To determine the property of each function code, set data to the function code.

#### Changing, reflecting, and saving function code data when the motor is running

Function codes are indicated by the following, based on whether they can be changed or not while the motor is running:

- Function codes marked with N (in the “Change when running” column of the function code tables given below): The data of these codes cannot be changed when the motor is running.
- Function codes marked with Y: The data for these codes can be changed with the  and  keys regardless of whether the motor is running or not. Pressing the  key will make the change effective and save it into the drive's memory.
- Function codes marked with Y\*: The difference from function codes marked with Y and others is that if the data for these codes is changed, the effect is immediate. However the change is not saved into the drive's memory. To save the change, press the  key. If you press the  key to exit the current state without pressing the  key, then the changed data will be discarded and the previous data will be restored for the current drive operation.

#### Using negative logic for programmable I/O terminals

The negative logic signaling system can be used for the digital input and output terminals by setting the function codes that specify properties for those terminals. Negative logic refers to inverted ON/OFF (logical value 1 (true)/0 (false)) state of input or output signal. An ON-active signal (the function takes effect for the ON signal.) in the normal logic system is functionally equivalent to OFF-active signal (the function takes effect for the OFF signal.) in the negative logic system.

To set the negative logic system for an I/O signal terminal, display data as 1000s (by adding 1000 to the data for the normal logic) in the corresponding function code and then press the  key.

For example, if a coast-to-stop command (BX: data = 7) is assigned to any one of digital input terminals [X1] to [X3] by setting any of function codes E01 through E03, then turning (BX) ON will make the motor coast to a stop. Similarly, if the coast-to-stop command (BX: data = 1007) is assigned, turning (BX) OFF will make the motor coast to a stop.

#### Restriction of data displayed on the LED monitor

Only four digits can be displayed on the 4-digit LED monitor. If you enter more than 4 digits of data valid for a function code, any digits after the 4th digit of the set data will not be displayed, however they will be processed correctly.

The following tables list the function codes available for the AF-300 Mini series of drives.

### F codes: Fundamental Functions

Func. code	Name	Date entry range	Min.	Unit	Change *1)	Factory setting
F codes: Fundamental Functions						
F00	Data protection	0_Data change enable 1_Data protection	-	-	Y	0
F01	Frequency command 1	0_Keypad operation (⏏ or ⏏key) 1_Voltage Input (Terminal 12) (0 to +10 Vdc) 2_Current Input (Terminal C1) (4 to 20mA dc) 3_Voltage Input (Terminal 12) and current Input (Terminal C1) 4_Potentiometer on the keypad	-	-	N	4
F02	Operation method	0_Keypad operation (FWD/REV change by external signal) 1_External signal (Digital input) 2_Keypad operation (FWD) 3_Keypad operation (REV)	-	-	N	2
F03	Maximum frequency 1	25.0 to 400.0 Hz	0.1	Hz	N	60.0
F04	Base frequency 1	25.0 to 400.0 Hz	0.1	Hz	N	60.0
F05	Rated voltage (at Base frequency)	0V_Voltage in proportion to power supply voltage 80 to 240V_AVR active (115V, 230V class) 160 to 500V_AVR active (460V class)	1	V	N	230 460
F07	Acceleration time 1	0.00 to 3600s _ 0.00 means acceleration time ignored (External soft start/stop)	0.01	s	Y	6.00
F08	Deceleration time 1	0.00 to 3600s _ 0.00 means acceleration time ignored (External soft start/stop)	0.01	s	Y	6.00
F09	Torque boost	0.0 to 20.0% (percentage against F05: Rated voltage) Setting becomes valid when F37 is set at 0 or 1,3,4	0.1	%	Y	
F10	Electronic thermal overload relay (Select)	1_Active (motor with self-cooled fan, standard motor) 2_Active (motor with forced-cooled fan)	-	-	Y	1
F11	(for motor protection)	0.00(Inactive), Approx. 1 to 135% of drive rated current	0.01	A	Y	GE Motor rated
F12	(Level) (Thermal time constant)	0.5 to 75.0min	0.1	min	Y	5.0
F14	Restart mode after momentary power failure (Select)	0_Inactive (Trip and alarm when power failure occurs.) 1_Inactive (Trip, and alarm when power recovers.) 4_Active (Restarts at output frequency on power failure occurrence, for general load) 5_Active (Restarts at starting frequency, for low-inertia load)	-	-	Y	0
F15	Frequency limiter (High)	0.0 to 400.0 Hz	0.1	Hz	Y	70.0
F16	(Low)	0.0 to 400.0 Hz	0.1	Hz	Y	0.0
F18	Bias frequency (for F01)	-100.00 to 100.00%	0.01	%	Y*	0.00
F20	DC brake (Starting freq.)	0.0 to 60.0 Hz	0.1	Hz	Y	0.0
F21	(Braking level)	0 to 100%	1	%	Y	0
F22	(Braking time)	0.00s (Inactive), 0.01 to 30.00s	0.01	s	Y	0.00
F23	Starting frequency	0.1 to 60.0 Hz	0.1	Hz	Y	1.0
F25	Stop frequency	0.1 to 60.0 Hz	0.1	Hz	Y	0.2
F26	Motor sound (Carrier freq.)	0.75 to 15k Hz	1	Hz	Y	2
F27	(Sound tone)	0_Level 0 1_Level 1 2_Level 2 3_Level 3	-	-	Y	0
F30	FMA Terminal (Output gain)	0 to 200%	1	%	Y*	100

F31	FMA Terminal (Function)	Selects from the following items by code. 0_ Output frequency (Before slip compensation) 1_ Output frequency (After slip compensation) 2_ Output current 3_ Output voltage 6_ Input power 7_ PID feedback value 9_ DC link circuit voltage 14_ Analog output test (+)	-	-	Y	0
F37	Load select/Auto torque boost/Energy-saving operation	0_ Variable torque load 1_ Constant torque load 2_ Automatic torque boost 3_ Energy-saving operation (Variable torque load during ACC/DEC.) 4_ Energy-saving operation (Constant torque load during ACC/DEC.) 5_ Energy-saving operation (Automatic torque boost ACC/DEC.)	-	-	N	1
F43	Current limiting 1 (Mode)	0_ Inactive 1_ At constant speed 2_ During acceleration and at constant speed	-	-	Y	0
F44	(Level)	20 to 200%	1	%	Y	200
F50	Electronic thermal overload (Discharge capability) relay (for braking resistor)	0 Internal braking resistor (optional) 1 to 900kW, 999(cancel)	1	kWs	Y	999
F51	(Allowable loss)	0.000(Braking resistor built-in type), 0.001 to 50.000	0.001	kW	Y	0.000

### E codes: Extension Terminal

E01	X1 terminal function (Select)	Selects from the following items by code.			N	0
E02	X2 terminal function				N	7
E03	X3 terminal function	0_(1000)Multistep freq. selection (0 to 7 stage)_SS1_ 1_(1001)Multistep freq. selection (0 to 7 stage)_SS2_ 2_(1002)Multistep freq. selection (0 to 7 stage)_SS4_ 4_(1004)ACC/DEC time selection (2 stages) _RT1_ 6_(1006)3-wire operation stop command_HLD_ 7_(1007)Coast-to-stop command_BX_ 8_(1008)Alarm reset_RST_ 9_(1009)Trip command (External fault)_THR_ 10_(1010)Jogging operation_JOG_ 11_(1011)Freq. set 2 / Freq. set 1_Hz2/Hz1_ 19_(1019)Write enable for Keypad (Data changeable)_WE-KP_ 20_(1020)PID control cancel_Hz/PID_ 21_(1021)Normal/Inverse mode changeover_IVS_ 24_(1024)Link enable (RS485 (standard), BUS (option))_LE_ 33_(1033)PID integration/differentiation reset_PID-RST_ 34_(1034)PID integration hold_PID-HLD_  _The number in ( ) indicates logical inverse. (OFF when short-circuited) _POT/External signal input can be changed over by Hz2/Hz1.			N	8
E10	Acceleration time 2	0.00 to 3600s	0.01	s	Y	6.00
E11	Deceleration time 2	0.00 to 3600s	0.01	s	Y	6.00
E20	Y1 terminal function (Select)	Selects from the following items by code.	-	-	N	0

E27	30A, B, C (Ry output)	0_(1000)drive running (Speed exists)_RUN_ 1_(1001)Frequency equivalence signal _FAR_ 2_(1002)Frequency level detection _FDT_ 3_(1003)Undervoltage detection signal_LU_ 5_(1005)Torque limiting/Current limiting_TL_ 6_(1006)Auto-restarting_IPF_ 7_(1007)Motor overload early warning_OL_ 26_(1026)Retry in operation_TRY_ 30_(1030)Lifetime alarm_LIFE_ 35_(1035)drive outputting_RUN2_ 36_(1036)Active drive in operation_ACT_ 37_(1037)Current detection_ID_ 41_(1041)Low level current detection_IDL_ 99_(1099)Alarm fault (for any fault)_ALM_	-	-	N	99
E31	Freq. detection 1 (FDT1) (Level)	0.0 to 400.0 Hz	0.1	Hz	Y	60.0
E34	OL early warning/Current (Level 1)	0.00(Inactive),1 to 200% of drive rated current	0.01	A	Y	GE Motor rated
E35	detection/Low level current (Timer 1)	0.01 to 600.00s	0.01	s	Y	10.00
E39	Coefficient of constant rate of feeding time	0.000 to 9.999	0.001	-	Y	0.000
E40	PID display coefficient A	-999 to 0.00 to 999	0.01	-	Y	100
E41	PID display coefficient B	-999 to 0.00 to 999	0.01	-	Y	0.00
E43	LED monitor (Select)	0_Speed monitor (select by E48) 3_Output current 4_Output voltage 9_Input power 10_PID final command value 12_PID feedback value 13_Timer value (timer operation)	-	-	Y	0
E45	See Note2.					
E46						
E47						
E48	LED monitor detail (Speed monitor select)	0_Output frequency (before slip compensation) 1_Output frequency (after slip compensation) 2_Setting frequency 4_Load shaft speed 5_Line speed 6_Constant rate of feeding time	-	-	Y	0
E50	Speed display coefficient	0.01 to 200.00	0.01	-	Y	30.00
E52	KEYPAD (Mode)	0_Function code data setting menu only 1_Data verification menu only 2_All menu	-	-	Y	0
E60	Potentiometer on the keypad (Function)	0_No function selection 1_Aux. freq. setting 1 2_Aux. freq. setting 2 3_PID process command 1	-	-	N	0
E61	Terminal 12 (Function)	Selects from the following by code.  0_No function selection 1_Aux. freq. setting 1 2_Aux. freq. setting 2 3_PID process command 1 5_PID feedback value	-	-	N	0
E62	Terminal C1		-	-	N	0

E98	FWD terminal function (Select)	Select from the following items by code.	-	-	N	98
E99	REV terminal function	0_(1000)Multistep freq. selection (0 to 7 stage) [SS1] 1_(1001)Multistep freq. selection (0 to 7 stage) [SS2] 2_(1002)Multistep freq. selection (0 to 7 stage) [SS4] 4_(1004)ACC/DEC time selection (2 stages) [RT1] 6_(1006)3-wire operation stop command [HLD] 7_(1007)Coast-to-stop command [BX] 8_(1008)Alarm reset [RST] 9_(1009)Trip command (External fault) [THR] 10 (1010)Jogging operation [JOG] 11_(1011)Freq. set 2 / Freq. set 1 [Hz2/Hz1] 19_(1019)Write enable for Keypad (Data changeable) [WE-KP] 20_(1020)PID control cancel [Hz/PID] 21(1021)Normal/Inverse mode changeover [IVS] 24(1024)Link enable (RS485 (standard), BUS (option)) [LE] 33_(1033)PID integration/differentiation reset [PID-RST] 34_(1034)PID integration hold [PID-HLD] 98_Forward/Stop command [FWD] 99_Reverse/Stop command [REV]	-	-	N	99
		_The number in ( ) indicates logical inverse. (OFF when short-circuited) _POT/External signal input can be changed over by Hz2/Hz1.				

### C codes: Control Functions of Frequency

C01	Jump frequency	1	0.0 to 400.0Hz	0.1	Hz	Y	0.0
C02		2					0.0
C03		3					0.0
C04	(Hysteresis)		0.0 to 30.0Hz	0.1	Hz	Y	3.0
C05	Multistep frequency setting	1	0.00 to 400.00Hz	0.01	Hz	Y	0.00
C06		2					0.00
C07		3					0.00
C08		4					0.00
C09		5					0.00
C10		6					0.00
C11		7					0.00
C20	Jogging frequency		0.00 to 400.00Hz	0.01	Hz	Y	0.00
C21	Timer operation (Mode select)		0_Inactive 1_Active	-	-	N	0
C30	Frequency command	2	0_Keypad operation (☺ or ☹ key) 1_Voltage Input(Terminal 12)(0 to +10v DC) 2_Current Input(Terminal C1)(4 to 20mA DC) 3_Voltage Input(Terminal 12) and current Input(Terminal C1) 4_Potentiometer on the keypad	-	-	N	2
C32	Analog input adj. (terminal 12)	(Gain)	0.00 to 200.00%	0.01	%	Y*	100.0
C33		(Filter)	0.00 to 5.00s	0.01	s	Y	0.05
C34		(Gain reference point)	0.00 to 100.00%	0.01	%	Y*	100.0
C37	Analog input adj. (terminal C1)	(Gain)	0.00 to 200.00%	0.01	%	Y*	100.0
C38		(Filter)	0.00 5.00s	0.01	s	Y	0.05
C39		(Gain reference point)	0.00 to 100.00%	0.01	%	Y*	100.0

C50	Bias (Freq. command 1) (Bias reference point)	0.00 to 100.00%	0.01	%	Y*	0.00
C51	Bias (PID (Bias value) command 1) (Bias reference point)	-100.00 to 100.00%	0.01	%	Y*	0.00
C52		0.00 to 100.00%	0.01	%	Y*	0.00

## P codes: Motor Parameters

P02	Motor (Capacity)	0.01 to 10.00kW (when P99 =0.3.4) 0.01 to 10.00 HP (when P99=1)	0.01 0.01	kW HP	N	Applied Motor
P03	(Rated current)	0.00 to 99.99A	0.01	A	N	GE Motor rated
P09	(Slip compensation gain)	0.0 to 200.0%	0.1	%	Y*	0.0
P99	Motor select	0_Motor Specification0 (FUJI 8 Series) 1_Motor Specification1 (HP Motor) 3_Motor Specification3 (FUJI 6 Series) 4_Others	-	-	N	1

## H codes: High Performance Functions

H03	Data initializing (Data reset)	0_Manual set value 1_Return to factory set value 2_Motor parameter initializing (Motor 1)	-	-	N	0
H04	Auto-reset (Times)	0_Inactive 1 to 10 times	1	Times	Y	0
H05	(Reset interval)	0.5 to 20.0s	0.1	s	Y	5.0
H06	Fan stop operation	0_Inactive 1_Active (1.5kW and above)	-	-	Y	0
H07	ACC/DEC pattern	0_Inactive (linear) 1_S-curve (weak) 2_S-curve (strong) 3_Curvilinear	-	-	Y	0
H12	Instantaneous overcurrent (Select) limiting	0_Inactive 1_Active	-	-	Y	1
	PTC thermistor (Select)	0_Inactive 1_Active	-	-	Y	0
H27	(Level)	0.00 to 5.00V	0.01	V	Y	1.60
H30	Serial link (Function select)	(Monitor) (Hz setting) (OPR command) 0_ Y N N 1_ Y RS485 N 2_ Y N RS485 3_ Y RS485 RS485	-	-	Y	0
H42	Main circuit capacitor measured value	Monitoring use			-	
H43	Cooling fan accumulated operation time	Monitoring use and change of cumulative operation time			Y	-
H50	Arbitrary point on (Frequency)	0.0(cancel) to 400.0 Hz	0.1	Hz	N	0.0
H51	polygonal V/f line (Voltage)	0 to 240V_AVR active (230V class) 0 to 500V_AVR active (460V class)	1	V	N	230 460
H54	ACC/DEC time (Jogging operation)	0.00 to 3600s	0.01	s	Y	6.00
H64	Low limiter (min. freq. when current or torque limiting active)	0.0 (Depends on F16_Freq. limiter (Low)) , 0.1 to 60.0Hz	0.1	Hz	Y	2.0
H69	Automatic deceleration control (Select) (Regeneration prevention)	0_Inactive 1_Active			Y	0
H70	Overload prevention control	0.00 (equivalent to DEC time), 0.01 to 100.0Hz/s, 999(cancel)	0.01	Hz/s	Y	999



H71	See Note2.						
H80	Current oscillation suppression gain	0.00 to 0.20	0.01	-	Y	0.20	
H95	See Note2.						
H96	STOP key priority / Start check function	Data STOP key priority function      0   1   2   3 OFF ON OFF ON      OFF ON OFF ON Start check function              OFF OFF ON ON	-	-	Y	3	
H97	Clear alarm data	Returns to zero after data clear by H97 setting at 1.	-	-	Y	-	
H98	Protection/ (Select) maintenance function	Data 0 1 2 3 4 5 6 7 Carrier frequency automatic DEC function OFF ON OFF ON OFF ON OFF ON Input phase loss protection OFF OFF ON ON OFF OFF ON ON Output phase loss protection OFF OFF OFF OFF ON ON ON ON	-	-	Y	3	

### J codes: Application Functions

J01	PID control (Select)	0_Inactive 1_Process control use (Normal action) 2_Process control use (Inverse action)	-	-	N	0
J02	(Remote process command)	0_Keypad panel 1_PID process command 1 4_Communication	-	-	N	0
J03	P (gain)	0.000 to 10.000 times	0.001	Times	Y	0.100
J04	I (Integration time)	0.0 to 3600.0s	0.1	s	Y	0.0
J05	D (Differentiation time)	0.0 to 600.00s	0.01	s	Y	0.00
J06	(Feedback filter)	0.0 to 900.0s	0.1	s	Y	0.5

## y codes: LINK Functions

y01	RS485 setting (Station address)	1 to 255	1	-	N	1
y02	(Mode select on no response error)	0_Trip and alarm (Er8) 1_Operation for y03 timer, alarm (Er8) 2_Operation for y03 timer, and retry to communicate. If retry fails, the drive trips (Er8). 3_Continuous operation	-	-	Y	0
y03	(Timer)	0.0 to 60.0s	0.1	s	Y	2.0
y04	(Baud rate)	0_2400bps 1_4800 2_9600 3_19200	-	-	Y	3
y05	(Data length)	0_8 bit 1_7 bit	-	-	Y	0
y06	(Parity check)	0_No checking 1_Even parity 2_Odd parity	-	-	Y	0
y07	(Stop bits)	0_2 bits 1_1 bits	-	-	Y	0
y08	(No response error detection time)	0_No detection 1 to 60s	1	s	Y	0
y09	(Response interval)	0.00 to 1.00s	0.01	s	Y	0.01
y10	(Protocol select)	0_Modbus RTU protocol 1_SX protocol (Loader protocol) 2_Fuji general-purpose drive protocol	-	-	Y	0
y99	Link function for supporting data input (Select)	(Freq. setting) (OPR command) 0_by H30 by H30 1_RS485 by H30 2_by H30 RS485 3_RS485 RS485	-	-	Y	0

\*1) Change during operation

N Disable.

Y Settled by FUNC/DATA key.

Y\* Changed by UP/DOWN key and settled by FUNC/DATA key.

Note1: The above Setting ranges may be limited by the signs or the number of digits.



Note2: Do not change the settings in E45 to E47, H71 and H95, as Drive does not use them although they are displayed.

## 5.2 Overview of Function Codes

This section provides an overview of the function codes frequently used for the AF-300 Mini series of drives.



Refer to the AF-300 Mini User's Manual, Chapter 9 "FUNCTION CODES" for details.

<b>F00</b>	<b>Data Protection</b>
------------	------------------------

Specifies whether function code data is to be protected from being accidentally changed by keypad operation. If data protection is enabled (F00 = 1), the  or  key operation to change data is disabled. In this case no function code data, except F00 data, can be changed from the keypad.

<b>F02</b>	<b>Running/Stopping and Rotational Direction</b>
------------	--

Selects the source issuing a run command: keypad or external control signal input.

- If F02 = 0, 2, or 3, the drive can run the motor using the  and  keys on the built-in keypad. The motor rotational direction can be specified in two ways, either by control signal input (F02 = 0) or by use of prefixed forward or reverse rotation (F02 = 2 or 3).

When F02 = 0, to specify the motor rotational direction by control signal input, assign the commands (FWD) and (REV) to terminals [FWD] and [REV], respectively. Turn on the (FWD) or (REV) for the forward or reverse direction, respectively, then press the  key to run the motor.

- If F02 = 1, the drive can run the motor by control signal inputs. To specify the motor rotational direction, assign the commands (FWD) and (REV) to terminals [FWD] and [REV], respectively. Turn on (FWD) or (REV) for the forward or reverse direction, respectively. If both of (FWD) and (REV) are turned on simultaneously, the drive immediately decelerates to stop the motor.

The table below lists the operational relationship between function code F02 (Running/Stopping and Rotational Direction), control signal inputs to terminals [FWD] and [REV], and the  key operation, which determines the rotational direction.

Running/ Stopping and Rotational Direction	Control Signal Inputs to Terminals [FWD] and [REV]				Run key on the built-in keypad		Motor rotational direction
	Function code F98 (REV) command		Function code F99 (FWD) command		OFF	ON	
Function code F02	OFF	ON	OFF	ON	OFF	ON	
0	✓	–	✓	–	✓	–	Stop
	✓	–	–	✓			
	–	✓	✓	–			
	–	✓	–	✓			
	✓	–	✓	–	–	✓	Stop
	✓	–	–	✓			Forward
	–	✓	✓	–			Reverse
	–	✓	–	✓			Stop
1	✓	–	✓	–	Not required.		Stop
	✓	–	–	✓			Forward
	–	✓	✓	–			Reverse
	–	✓	–	✓			Stop

<b>F03</b>	<b>Maximum Frequency</b>
------------	--------------------------

Sets the maximum frequency to drive the motor. Setting the frequency out of the rated range for the equipment driven by the drive may damage the system or cause it to malfunction. Set a maximum frequency appropriate for the equipment.

**CAUTION**

As the drive can easily set high-speed operation, carefully verify the allowable specifications of the motor and its load before changing speed settings.

**Otherwise injuries could occur.**

<b>F04</b>	<b>Base Frequency</b>
------------	-----------------------

Set the rated frequency printed on the nameplate labeled on the motor.

<b>F05</b>	<b>Rated Voltage (at Base Frequency)</b>
------------	--

Set 0 or the rated voltage printed on the nameplate labeled on the motor.

- If 0 is set, the drive outputs the same voltage and frequency of the the source power. In this case, the output voltage will vary in line with any variance in input voltage.
- If the data is set to anything other than 0, the drive automatically keeps the output voltage constant in line with the setting. When any of the automatic torque boost, automatic energy saving or slip compensation are active, the voltage settings should be equal to the rated voltage of the motor.

NOTE: If the rated voltage of the motor is set to F05, the motor efficiency will be increased more than when 0 is set. Therefore, when brakes are applied to the motor, energy loss decreases and the motor regenerates higher braking energy than it would otherwise. Note that the allowable power consumption capacity of the drive for braking energy is limited by the specifications, so it may be necessary to increase deceleration time or to use an external braking resistor.

<b>F09</b> <b>F37</b>	<b>Load Selection/Auto Torque Boost/Auto Energy Saving Torque Boost</b>
--------------------------	---

There are two different properties of loads – the torque load reversal proportional to the square of speed and the constant torque load. You can select a V/f pattern optimized to the load properties.

**Manual torque boost**

This feature manually adjusts the starting output voltage by setting F09 to an optimal torque boost rate to match the motor and its load. Select a V/f pattern from two types of loads with F37.

Setting an excessive torque boost rate may result in over-excitation and overheating of the motor during no-load operation.

Manual torque boost keeps the output voltage constant even if the load varies, assuring stable motor operation.

**Automatic torque boost**

This feature automatically optimizes the output voltage to match the motor and its load. Under a light load, it decreases the output voltage to prevent the motor from over-excitation; under heavy load, it raises the output voltage to increase torque.

Since this feature is related to the motor characteristics, it is necessary to set the rated voltage at base frequency (F05) and motor parameters (P codes) properly.

**Auto energy saving**

This feature controls the terminal voltage of the motor automatically to minimize motor power loss. (Note that this feature may not be effective depending on the properties of the motor. Check the properties before using this feature.)

The drive enables this feature only for constant speed operation. During acceleration and deceleration, the drive will run with manual or automatic torque boost, depending on the data setting of function code F37. If auto energy saving operation is enabled, switching the motor from constant speed will become less responsive. Do not use this feature for a system that requires quick acceleration and deceleration.

Given below are proper setting examples with the combination of F09 and F37.

- If auto energy saving operation is not selected:

Load type	To select manual torque boost, set:	To select automatic torque boost, set:
Variable torque	F37 = 0 F09 = 0.0 to 20.0 (%)	F37 = 2
Constant torque	F37 = 1 F09 = 0.0 to 20.0 (%)	

– If auto energy saving operation is enabled (by selecting load properties during acceleration and deceleration)

Load type	To select manual torque boost, set:	To select automatic torque boost, set:
Variable torque	F37 = 3 F09 = 0.0 to 20.0 (%)	F37 = 5
Constant torque	F37 = 4 F09 = 0.0 to 20.0 (%)	

<b>F10 to F12</b>	<b>Electronic Thermal Overload (Property Selection, Overload Detection Level, and Thermal Time Constant)</b>
-------------------	--

Function codes F10 through F12 set the thermal properties of the motor, including the thermal time constant. This imputes motor overload using the embedded electronic thermal detection of the drive, which calculates motor temperature indirectly based on the drive's internally measured output current. F11 is used to determine the overload detection level.

NOTE: Thermal properties of the motor specified by these function codes are also used for the overload early warning. Therefore, even if you need only the overload early warning, set these property data to function codes F10 and F12.

F10 selects the motor's cooling method: built-in cooling fan or external forced-ventilation.

Set F10 to:	If the cooling property of the motor is:
1	Built-in cooling fan of general-purpose motor (self-cooled) (The cooling performance will decrease in low frequency operation.)
2	Drive-driven or high-speed motor (force-ventilated) (Cooling performance remains constant with speed.)

F11 sets the operation level of the electronic thermal detection to the current value. Set approximately 1.0 to 1.1 multiples of the allowable continuous current (rated current of the motor) at the rated drive frequency of the motor under normal running conditions. To disable the electronic thermal detection, set F11 to 0.00.

F12 sets the thermal time constant of the motor. The drive interprets the time constant as an operation period of the electronic thermal detection. During the specified operation period, the drive will activate electronic thermal detection if 150% of the operating current specified by F11 flows continuously. The time constant of GE

general purpose motors and other induction motors is set to 5 minutes by factory default.

Data entry range: 0.5 to 75.0 (minutes, in 0.1-minute increments).

REFERENCE: Refer to the AF-300 Mini User's Manual, Chapter 9 "FUNCTION CODES" for details of the built-in cooling fan and properties of electronic thermal detection.

<b>F14</b>	<b>Restart after Instantaneous Power Failure</b>
------------	--

Selects the action of the drive to be followed when an instantaneous power failure occurs.

If the drive detects that the voltage of the intermediate dc circuit drops to below the specified undervoltage limit, it interprets the state as a momentary power failure. However, if the drive runs with a light load and the period of the power failure is short, then it does not detect the power failure and continues to run.

– Trip immediately (F14 = 0)

If an instantaneous power failure occurs when the drive is in Run mode such that the drive detects undervoltage of the intermediate dc circuit, then the drive immediately shuts down its outputs and displays the undervoltage alarm "LU " on the LED monitor. The motor will coast to a stop. The drive will not restart automatically.

– Trip after recovery of power (F14 = 1)

If an instantaneous power failure occurs when the drive is in Run mode so that the drive detects undervoltage of the intermediate dc circuit, then the drive immediately shuts down its outputs without transferring to Alarm mode or displaying the undervoltage alarm "LU ". The motor will coast to a stop. When the power is recovered, the drive will enter Alarm mode for undervoltage.

– Restart at the frequency at which the power failure occurred (F14 = 4)

If an instantaneous power failure occurs when the drive is in Run mode so that the drive detects undervoltage of the intermediate dc circuit, then the drive saves the current output frequency.

When the power is recovered with any run command being ON, the drive will restart at the saved frequency. During the instantaneous power failure, if the motor speed drops, the current limiter facility of the drive will be activated and automatically lower the output frequency. On synchronization of the output frequency and motor speed, the drive accelerates up to the previous output frequency. Refer to the figure (F14 = 4) on the following page for details.

However to synchronize output frequency and motor speed, the momentary overcurrent limiter (H12 = 1) should be enabled.

This setting is optimal for cases in which due to the heavy moment of inertia of its load the motor would take a long time to coast to a stop because of power failure.

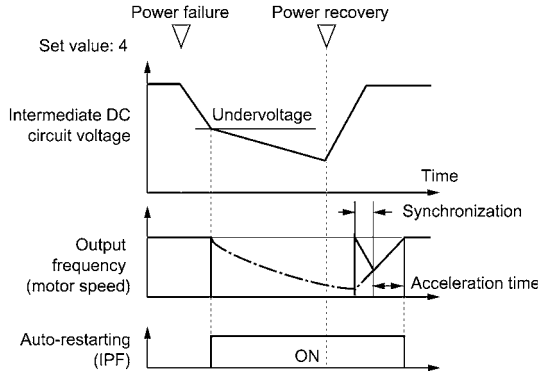

– Restart at the starting frequency (F14 = 5)

If an instantaneous power failure occurs when the drive is in Run mode so that the drive detects undervoltage of the intermediate dc circuit, then the drive immediately shuts down its outputs. After power is recovered, entry of any run command will restart the drive at the frequency specified by function code F23. Refer to the figure (F14 = 5) on the following page for details.

This setting is optimal for cases where due to a high load with a very low moment of inertia the motor quickly comes to a stop when de-energized

## WARNING

If you select the auto restart function “active” in the restart mode after instantaneous power failure (function code F14), the drive automatically restarts running the motor when the power is recovered.

Design the machine so that human safety is ensured after restarting.

**Otherwise an accident could occur.**

**F15,  
F16**

## Frequency Limiter (Peak and Minimum)

Frequency limiter F15 limits the peak or maximum output frequency. Frequency limiter F16 maintains the output frequency at a minimum level even if the set frequency is lower than that. Refer to the figure below.

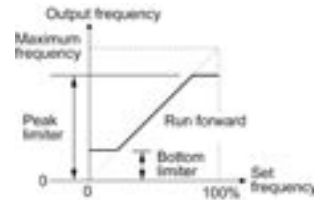

NOTE: Set the peak and minimum frequencies correctly; otherwise, the drive may not operate. Maintain the following relationship between the limiters:

- (Peak frequency) > (Minimum frequency), (Starting frequency), (Stop frequency)
- (Minimum frequency) < (Maximum frequency)

**F18  
C50  
C32,  
C34  
C37,  
C39**

**Bias (for Frequency Command 1)  
Bias (Bias reference point for frequency command 1)  
Analog Input Adjustment (Gain and gain reference point for terminal input [12])  
Analog Input Adjustment (Gain and gain reference point for terminal input [C1])**

If you select any analog input for frequency command 1, it is possible to define the relationship between the analog input and the set frequency arbitrarily by combining the settings for bias (F18), bias reference point (C50), gains (C32 and C37), and gain reference points (C34 and C39).

As illustrated in the graph on the next page, the relationship between the set frequency and analog input for frequency command 1 is shown by a straight line passing through points “A” and “B.” “A” is determined by the bias (F18) and its reference point (C50). “B” is determined by the gain (C32 or C37) and its reference point (C34 or C39). The combination of C32 and C34 will apply for terminal [12] and that of C37 and C39 for terminal [C1].

The bias (F18) and gain (C32 or C37) should be set, supposing the maximum frequency as 100%. The bias reference point (C50) and gain frequency point (C34 or C39) should be set, supposing the full scale (10 Vdc or 20 mAdc) as 100%.

NOTE: Analog input under the bias reference point is limited by the bias data.

The relations stated above are indicated in the following expressions.

(1) If analog input ≤ bias reference point:

$$\text{Frequency Setting 1 (\%)} = \text{Bias (F18)}$$

(2) If analog input > bias reference point:

$$\begin{aligned} \text{Frequency Setting 1 (\%)} &= \frac{(\text{Gain}) - (\text{Bias})}{(\text{Gain reference point}) - (\text{Bias reference point})} (\%) \leftrightarrow \text{Analog input (\%)} \\ &\quad + \frac{(\text{Bias}) \leftrightarrow (\text{Gain reference point}) - (\text{Gain}) \leftrightarrow (\text{Bias reference point})}{(\text{Gain reference point}) - \text{Bias reference point}} \\ &= \frac{\text{C32} - \text{F18}}{\text{C34} - \text{C50}} (\%) \leftrightarrow \text{Analog input (\%)} + \frac{\text{F18} \leftrightarrow \text{C34} - \text{C32} \leftrightarrow \text{C50}}{\text{C34} - \text{C50}} \end{aligned}$$

In the above expressions, it is assumed that each function code expresses its data.

Example: Setting the bias, gain and its reference point when analog input range from 1 to 5 Vdc is selected for the frequency command 1.

(Point A)

If the analog input is at 1 V, the set frequency is 0 Hz. Therefore, the bias is 0% (F18 = 0). Since 1 V is the bias reference point and it is equal to 10% of 10 V, then the bias reference point should be 10% (C50 = 10).

(Point B)

If the analog input is at 5 V, the set frequency comes to be the maximum value. Therefore, the gain is 100% (C32 = 100). Since 5 V is the gain reference point and it is equal to 50% of 10 V, then the gain reference point should be 50% (C34 = 50).

NOTE: When using the function codes for setting a standalone gain or bias without changing any reference points, the setting procedure for the function codes is the same as that of GE Fuji's conventional drive models.

<b>F20 to F22</b>	<b>DC Brake (Starting frequency, Braking level, and Braking time)</b>
-------------------	---

These function codes enable a dc brake to prevent the motor from coasting by its inertia while it is decelerating to a stop. Set function codes F20 for the starting frequency, F21 for the braking level, and F22 for the braking time as follows.

### CAUTION:

The brake function of the drive does not provide mechanical holding means.

**Otherwise injuries could occur.**

<b>F43, F44</b>	<b>Current Limiter (Operation condition and Limiting level)</b>
-----------------	---

F43 enables or disables the current limiter. If it is enabled, the drive controls the output frequency while keeping the current set to the value in F44 in order to prevent the motor from stalling.

With F43, you may select whether the current limiter works during constant speed operation only (F43 = 1) or during both acceleration and constant speed operation (F43 = 2). Set F43 to 1, for example, to drive the motor at maximum performance in the acceleration zone and to limit the drive current in the constant speed zone.

### WARNING

If the current limiter function has been selected, the drive may operate with an acceleration/deceleration time or frequency different from those set. Design the machine so that safety is ensured even if this happens.

**Otherwise an accident could occur.**

<b>F50, F51</b>	<b>Electronic Thermal (Discharging capability and Allowable loss)</b>
-----------------	---

These function codes configure the electronic thermal feature to protect the braking resistor from overheating.

For built-in braking resistors, set function codes F50 and F51 to 0 and 0.00, respectively.

NOTE: Depending on the energy dissipation margin of the braking resistor, the electronic thermal protection may operate and issue the overheat alarm “dbH,” even though the actual temperature of the resistor is within limits. Check braking resistor performance again and review the data setting of function codes F50 and F51.

<b>E01 to E03, E98, E99</b>	<b>Command Assignment for Terminals [X1] to [X3], [FWD] and [REV]</b>
-----------------------------	---

E01 to E03, E98 and E99 may assign commands (listed below) to terminals [X1] to [X3], [FWD], and [REV] which are general-purpose programmable input terminals.

These function codes may also switch the logic system between normal and negative to define the property of those input terminals so that the drive logic may interpret either the ON or OFF status of each terminal as active. The default setting is normal logic, that is “Active ON.”

To assign negative logic input to any input terminal, set the function code to the value of 1000s shown in ( ) in Section 5.1 “Function Code Tables.” To keep explanations as simple as possible, the examples shown below are all written for the normal logic system.

- Select multi-step frequency (1 to 7 steps) – (SS1), (SS2), and (SS4)  
(Function code data = 0, 1, and 2)

Switching digital input signals (SS1), (SS2), and (SS4) ON/OFF may switch the current set frequency to that defined by function codes C05 through C11 (multi-step frequencies). With this, the drive may drive the motor at a maximum of 8 different speeds.

The table below lists the frequencies that can be obtained by the combination of switching (SS1), (SS2), and (SS4). In the column “Selected frequency,” “Other than multi-step frequency” represents the set frequencies defined by frequency command 1 (F01), frequency command 2 (C30), and others.

(SS4)	(SS2)	(SS1)	Selected frequency
OFF	OFF	OFF	Other than multi-step frequency
OFF	OFF	ON	C05 (multi-step frequency 1)
OFF	ON	OFF	C06 (multi-step frequency 2)
OFF	ON	ON	C07 (multi-step frequency 3)
ON	OFF	OFF	C08 (multi-step frequency 4)
ON	OFF	ON	C09 (multi-step frequency 5)
ON	ON	OFF	C10 (multi-step frequency 6)
ON	ON	ON	C11 (multi-step frequency 7)

- Select acceleration/deceleration (2 steps) – (RT1)  
(Function code data = 4)

Digital input signal (RT1) assigned to the specified terminal ON/OFF may switch combinations between acceleration/deceleration time 1 (defined by function codes F07 and F08) and acceleration/deceleration time 2 (defined by E10 and E11).

Turning (RT1) ON, for example, enables the drive to drive the motor using acceleration/deceleration time 2.

- Select 3-wire operation command – (HLD)  
(Function code data = 6)

Digital input signal (HLD) may self-hold the forward (FWD)/reverse (REV) run commands given at the external signal input terminals to enable 3-wire drive operation.

Shorting the circuit between the (HLD)-assigned terminal and terminal [CM] will self-hold the (FWD) or (REV) command. Opening the circuit will release the hold.

- Coast-to-stop command – (BX)  
(Function code data = 7)

Shorting the circuit between the (BX)-assigned terminal and terminal [CM] will immediately shut down the drive output allowing the motor to coast to a stop without issuing any alarm.

- Reset alarm – (RST)  
(Function code data = 8)

When the protection facility has been activated (the drive is in Alarm mode), shorting the circuit between the (RST)-assigned terminal and terminal [CM] will reset the alarm output on terminals [Y1] and [30A,B,C]. Opening the circuit will release all the alarm indications to restart operation. Allow 10 ms or more for the short-circuit time. (RST) should be kept OFF for normal drive operation.

- Alarm from external equipment – (THR)  
(Function code data = 9)

When the motor is running, opening the circuit between the (THR)-assigned terminal and terminal [CH] will immediately shut down the drive output and issue the alarm “OH2.” The motor will coast to a stop.

- Ready for jogging – (JOG)  
(Function code data = 10)



Turning ON the (JOG) command makes the motor ready for jogging. Use this command for fine adjustment of workpiece positioning, for example.

When the motor is ready for jogging with (JOG) being ON, pressing the  key or turning the (FWD) or (REV) command ON will start the motor to jog.



If the  key is released, the motor will decelerate to a stop.

Jogging operation follows the settings of:

- Jogging frequency set by function code C20
- Acceleration or deceleration time set by function code H54

Simultaneous  +  keying may also make the motor ready for jogging depending upon whether keypad operation or terminal command operation is selected and whether the (JOG) command is ON or OFF, as listed below.

When operated from keypad (F02 = 0, 2, or 3)

If (JOG) is:	 +  keys	The motor becomes ready for:
ON	Disabled.	Jogging
OFF	Toggles between normal and jogging.	Normal running
		Jogging



When terminal command operation is selected (F02 = 1), simultaneous + keying is disabled.

- Select frequency command 2 or 1 – (Hz2/Hz1) (Function code data = 11)

Turning the digital input signal (Hz2/Hz1) ON/OFF may switch the frequency setting method between frequency command 1 (defined by function code F01) and frequency command 2 (defined by function code C30).

Turning the (Hz2/Hz1) command ON allows the frequency command 2 to be selected.

- Enable editing of function code data from the keypad – (WE-KP) (Function code data = 19)

Turning OFF the (WE-KP) command prohibits changing of function code data from the keypad.

Only when the (WE-KP) command is turned ON, you may access function code data from the keypad according to the setting of function code F00 as listed below.

If (WE-KP) is set to:	F00	Function
ON	0	Permit editing of function code data
	1	Inhibit editing of function code data except F00
OFF	Disabled	Inhibit editing of function code data

If the (WE-KP) command is not assigned to any terminal, the drive will interpret (WE-KP) as being always ON.

- Disable PID control – (Hz/PID) (Function code data = 20)

Turning the (Hz/PID) command ON/OFF enables or disables the PID control.

If the PID control is disabled with the (Hz/PID) being OFF, the drive runs the motor with the frequency manually set by any of multi-step, keypad, or analog input.

REFERENCE: Refer to the AF-300 Mini User’s Manual, Chapter 4, Section 4.8 “PID Frequency Command Generator” for details.

- Switch Normal/Inverse operation – (IVS) (Function code data = 21)

Turning the (IVS) command ON/OFF switches the output frequency control between normal (proportional to the set frequency components) and inverse operation for the PID process or manually set frequencies. To select the inverse operation, switch the (IVS) command to ON.

When the PID control is enabled, turning the (IVS) command ON inverts the PID process control selected by function code J01. For example, if the PID process

control is normal, turning it ON switches it to inverse, or vice versa.

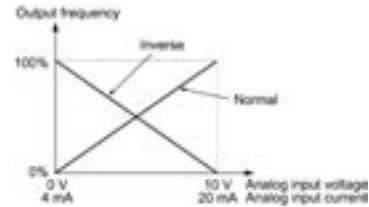

- Select link operation – (LE) (Function code data = 24)

Turning ON the (LE) command selects link operation. The drive will run the motor with the frequency command or drive command given via the RS485 communications facility defined by function code H30.

If the (LE) command is not assigned to any terminal, the drive will interpret (LE) as being always ON.

- Reset PID integral and differential components – (PID-RST) (Function code data = 33)

Turning ON the (PID-RST) command resets the PID integral and differential components.

- Hold PID integral component – (PID-HLD) (Function code data = 34)

Turning ON the (PID-HLD) command holds the current drive output voltage constant by suppressing an increase of PID integral component.

- Run forward – (FWD) (Function code E98/E99 data = 98)

If the (FWD) command is turned ON, the drive runs the motor forward; if OFF, it decelerates the motor to a stop.

- Run reverse – (REV) (Function code E98/E99 data = 99)

If the (REV) is turned ON, the drive runs the motor in reverse; if OFF, it decelerates the motor to a stop.

<b>E20, E27</b>	<b>Terminal Function for [Y1], [30A], [30B] and [30C]</b>
-----------------	---

E20 to E27 may assign output signals to terminals [Y1] (transistor switch) and [30A], [30B] and [30C] (mechanical relay contacts) which are general purpose programmable output terminals.

These function codes may also switch the logic system between normal and negative to define the property of those output terminals so that the drive logic may interpret either the ON or OFF status of each terminal as active.

Terminals [30A], [30B], and [30C] are mechanical relay contacts. In normal logic, if an alarm occurs, the relay will be excited so that [30A] and [30C] will be short-circuited, signaling an occurrence of the error to external equipment. On the other hand, in negative logic the relay will cut off the excitation current to open [30A] and [30C]. This may be useful for the implementation of failsafe power systems.

NOTE: When negative logic is utilized, the drive switches all output signals to the active side (for example, the alarm side). Therefore, if it is desirable to avoid system malfunctions caused by this, interlock the signals to keep them ON using an external power source or similar.

To keep explanations as simple as possible, the examples shown below are all written assuming the normal logic system.

- Drive running (Speed > 0) – (RUN)  
(Function code data = 0)

This output signal is used to tell the external equipment that the drive is running at a speed faster than 0. It switches ON when the drive output frequency exceeds the start frequency of the motor and switches OFF when it does not or when the drive is dc-braking the motor.

- Frequency equivalence – (FAR)  
(Function code data = 1)

This signal is turned ON when the difference between the output and set frequencies has come into the allowable error zone (preset to 2.5 Hz).

- Frequency detection – (FDT)  
(Function code data = 2)

This signal is turned ON when the output frequency of drive has come to the frequency detection level specified by function code E31. It is turned OFF when the output frequency drops lower than the detection level for 1 Hz (hysteresis band of the frequency comparator: preset to 1 Hz).

- Undervoltage detection – (LU)  
(Function code data = 3)

This signal is turned ON when the voltage of the intermediate dc circuit of the drive drops below the specified level, or when the motor stops due to activation of the undervoltage protection feature (undervoltage trip). It is turned OFF if the intermediate dc voltage exceeds the specified voltage.

- Torque limiting (Current limiting) – (IOL)  
(Function code data = 5)

This signal is turned ON when the drive is limiting the motor supply current by activating the current limiter of either software (F43: Function select, F44: Operation

level) or hardware (H12 = 1: Current limit). The minimum ON-duration is 100 ms.

- Auto-restart after recovery of power – (IPF)  
(Function code data = 6)

This signal is turned ON during the period from when the drive detects the undervoltage of the intermediate dc circuit and shuts down the output (if auto-restart after recovery of power is selected (F14 = 4 or 5)) until auto-restarting (the output frequency has recovered up to the set frequency). At the moment of auto-restarting this signal is turned OFF.

- Motor overload early warning – (OL)  
(Function code data = 7)

This signal is used to issue a motor overload early warning in order to enable corrective action to be taken before the drive detects a motor overload (OL1 alarm) and shuts down its output.

The motor properties are specified by function codes F10 (electronic thermal selection) and F12 (thermal time constant). If a value calculated from the settings of F10 and F12 exceeds the detection level of the early warning set by function code E34, this signal is turned ON. Normally, the recommended set current level for E34 is 80 to 90% of the allowable continuous load current set by function code F11.

NOTE: Function code E34 is effective not only for the motor overload early warning (OL), but also the current detection (ID) and low level current detection (IDL).

- Retry in operation – (TRY)  
(Function code data = 26)

This signal is turned ON when the retry facility specified by function codes H04 (number of retries) and H05 (retry interval) is activated. Refer to function codes H04 and H05 for details of the output timing and number of retries.

- Service life alarm – (LIFE)  
(Function code data = 30)

This signal is turned ON when it is judged that the service life of capacitors (in the intermediate dc circuit, and electrolytic capacitors on the printed circuit boards) or the cooling fan has expired.

This facility provides tentative information for parts service life. If this signal is issued, check the service life of these parts in your system according to the maintenance procedure to determine whether they should be replaced or not. To maintain stable and reliable operation and avoid unexpected failures, daily and periodic maintenance must be performed.

REFERENCE: For details, refer to Chapter 7, Section 7.2, Table 7.2 “Replacement Parts Judgement with Menu #5 “Maintenance Information” as a Guide.”

- Drive running – (RUN2)  
(Function code data = 35)

This signal is turned ON when the main switching circuit (Insulated Gate Bipolar Transistor (IGBT) gates) is activated; it is OFF when it is not activated.

Related item: Refer to “drive running (Speed > 0) – (RUN).”

- Overload prevention control – (OLP)  
(Function code data = 36)

This signal is turned ON when the overload prevention facility is activated if the frequency drop rate comes to be the setting specified by function code H70. The minimum ON-duration is 100 ms.

REFERENCE: For details of the overload prevention control, refer to the descriptions of function code H70.

- Current detection – (ID)  
(Function code data = 37)

This signal is turned ON when the output current exceeds the operation level specified by function code E34 and stays in this status for the duration specified by function code E35 (on delay timer). The minimum ON-duration is 100 ms.

NOTE: Function codes E34 and E35 are effective not only for current detection (ID), but often also for overload early warning (OL) and low level current detection (IDL).

- Low level current detection – (IDL)  
(Function code data = 41)

This signal is turned ON when the output current drops below the operation level specified by function code E34 and stays in this status for the duration specified by function code E35 (on delay timer). The minimum turning ON time is 100 ms.

NOTE: Function codes E34 and E35 are effective not only for the low level current detection (IDL), but often also for the overload early warning (OL) and current detection (ID).

- Alarm relay contact output (for any fault) – (ALM)  
(Function code data = 99)

This signal is turned ON if the protection facility is activated so that the drive enters Alarm mode.

## E50 Coefficient for Speed Indication

This function code sets a coefficient to be used for setting the constant feeding rate time, load shaft speed or line speed and for displaying its output status.

$$\text{Constant Feeding Rate Time (min)} = \frac{\text{Coeff. of Special Indication (E50)}}{\text{Freq.} \times \text{Coeff. for Const. Feeding Rate Time (E39)}}$$

$$\text{Load Shaft Speed} = (\text{E50: Coeff. for Speed Indication}) \times \text{Frequency (Hz)}$$

$$\text{Line Speed} = (\text{E50: Coeff. for Speed Indication}) \times \text{Frequency (Hz)}$$

Where, Freq. is the set frequency if each expression is for one of the set data for the constant feeding rate time, load shaft speed, or line speed; it is the output frequency if each expression is for the output status monitor.



NOTE: PID display coefficients A and B (E40 and E41) are the exclusive conversion factors to equate an indicated value with the process command and feedback values in PID control.

## C21 Timer Operation





Enables or disables timer operation. If it is enabled, entering a run command will make the drive run the motor for the period preset in the timer.

An example of timer operation:

Setting up the timer conditions beforehand

- Set C21 to 1 to enable timer operation.
- To display the timer count on the LED monitor, set function code E43 (LED monitor) to 13 (Timer count).
- Set up the frequency for the timer operation using the built-in potentiometer or the  /  keys. If the LED displays the timer count, press the  key to switch it to the speed monitor and then set the frequency for the timer operation.

Timer operation (by giving a run command with the  key):

- 1) Use the  or  key to set the timer count (in seconds) while monitoring the current count displayed on the LED monitor. Note that the timer count is expressed as integers.
- 2) Press the  key to run the motor, and the timer will start to count down. The moment the timer finishes the countdown, the drive stops running the motor even if the  key is not pressed. (Timer operation is possible even when the timer count is not displayed on the LED monitor.)
- 3) After the drive decelerates the motor to a stop, the timer count on the LED monitor will flash.

NOTE: If timer operation started by the terminal command (FWD) is finished and the drive decelerates the motor to a stop, then the LED monitor displays “End” and the monitor indication (“0” if the timer count is selected) alternately. Turning (FWD) OFF will switch the LED back to the monitor indication.

Refer to the AF-300 Mini User’s Manual, Chapter 4 “BLOCK DIAGRAMS FOR CONTROL LOGIC” for details.

<b>P02, P03</b>	<b>Motor Parameter (Rated capacity and rated current)</b>
-----------------	---

Set the nominal rated capacity denoted on the rating nameplate of the motor.

<b>P09</b>	<b>Motor Parameter (Slip compensation gain)</b>
------------	---

Set the gain to compensate the motor slip frequency as a reference at 100% based on the typical slip of any drive model. Set the compensation gain with respect to motor speed.

Typical rated slip frequencies for 100%

Rated capacity (kW/hp)	Typical motors rated in hp (Hz)	Typical motors rated in kW (Hz)	Other motors (Hz)
0.06/0.1	2.50	1.77	1.77
0.1/0.12	2.50	1.77	1.77
0.2/0.25	2.50	2.33	2.33
0.4/0.5	2.50	2.40	2.40
0.75/1	2.50	2.33	2.33
1.5/2	2.50	2.00	2.00
2.2/3	1.17	1.80	1.80
3.7/5	1.50	1.93	1.93

The 230 V and 460 V series of motors share the same data listed above.

<b>P99</b>	<b>Motor Selection</b>
------------	------------------------

In order to perform automatic control features such as the auto torque boost/auto energy saving and slip compensation or overload protection for the motor (electronic thermal), the drive invokes the rated values and properties of the motor. To match the drive properties of the drive and motor, set the motor properties to this code and set function code H03 (Initialize data) to 2 to initialize the motor parameter. This action automatically updates the data of function code P03 and the constants used inside the drive.

When using GE standard motors, select the data listed below according to model.

- P99 = 1 for GE standard motors
- P99 = 4 for Other motors

For motors from other manufacturers or unknown models, set P99 to 4 (Other motors).

<b>H04, H05</b>	<b>Retry (Times, latency time)</b>
-----------------	------------------------------------

To automatically exit from the alarm status and restart the drive, use the retry functions. The drive automatically exits from Alarm mode and restarts without issuing a block alarm even if it has already entered the forced Alarm mode. If the drive has entered Alarm mode many times in excess of the number of times specified by function code H04, it issues a block alarm and does not exit Alarm mode for restarting.

Listed below are the recoverable alarm statuses of the drive.

Alarm Status	LED monitor display
Instantaneous overcurrent protection	0C1, 0C2 or 0C3
Overvoltage protection	0U1, 0U2 or 0U3
Heat sink overheated	0H1
Motor overheated	0H4
Braking resistor overheated	dbH
Motor overloaded	0L1
drive overloaded	0LU

- Retry times (H04)

Set the number of retry times for automatic exit from Alarm mode. If the drive has entered Alarm mode many times in excess of the number of times specified by the function code, it issues a block alarm and does not exit alarm mode for restarting.

## WARNING

If the retry function has been selected, the drive may automatically restart according to some causes after tripping. (Design the machine so that human safety is ensured after restarting.)

**Otherwise an accident could occur.**

- Retry latency time (H05)

Sets the latency time for automatic exit from Alarm mode. Refer to the timing scheme diagram below.

Operation timing chart

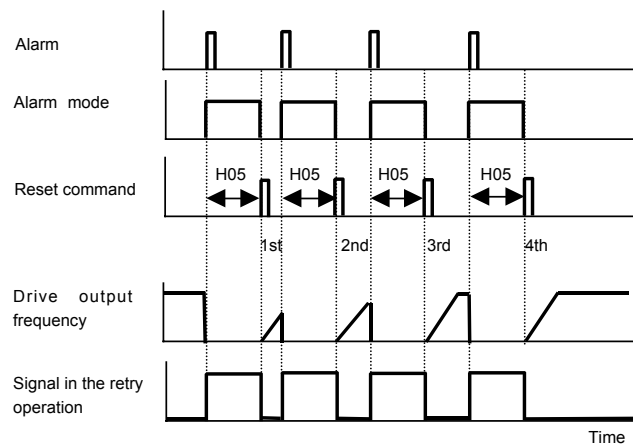

<b>H07</b>	<b>Gradual Acceleration/Deceleration</b>
------------	--

Specifies the acceleration and deceleration patterns (output frequency patterns).

Linear acceleration/deceleration

The drive runs the motor with the constant acceleration and deceleration.

S-curved acceleration/deceleration

To reduce the impact that the drive motor gives its load during acceleration/deceleration, the drive gradually accelerates/decelerates the motor at the both ends of the acceleration/deceleration zones.

Curvilinear acceleration/deceleration

The drive controls the motor for maximum performance, with the following acceleration/deceleration pattern:

- Linear acceleration/deceleration of constant torque output for the motor in the zone under the base frequency
- Two times speed and a half acceleration/ deceleration at the base frequency in the zone over the base frequency.

<b>H12</b>	<b>Instantaneous Overcurrent Limiting</b>
------------	---

Selects whether the drive will perform current limiting processing or cause an overcurrent trip if the output current exceeds the instantaneous overcurrent limit level.

If instantaneous overcurrent limiting is enabled, the drive will immediately turn off its output gates to suppress the increase of current and control the output frequency.

If current limiting processing makes the motor decrease its torque temporarily and causes a problem, then disable the overcurrent limiting to cause an overcurrent trip and apply brake to the motor.

NOTE: The same functions to limit the output current are implemented by software as the function codes F43 and F44. Generally, software features have an operation delay. Even if you have enabled the function codes F43 and F44, enable the function code H12.

<b>H69</b>	<b>Regenerative Energy Suppressing</b>
------------	--

The moment that regenerative energy exceeding the absorptive capacity of drive occurs during motor braking, the drive will trip and enter into Alarm mode due to overvoltage. If regenerative energy suppressing is enabled, the drive lengthens the deceleration time for 3 times the set time as long as the intermediate dc voltage exceeds the preset voltage suppressing level, and decreases the deceleration torque for 1/3. In this way the drive decreases the regenerative energy progressively.

This control is to suppress the torque generated by the motor in deceleration. However when a load brakes the motor the control has no effect, and should not be used.

When the drive features a braking resistor, disable this control. Otherwise, the braking resistor and the control may conflict with each other, and may adversely affect the deceleration time.

<b>H70</b>	<b>Overload Prevention Control</b>
------------	------------------------------------

Enables overload suppressing control. If enabled, this function code is used to set the deceleration (Hz/s).

Before the drive enters alarm mode due to the heat sink overheating or an overload (alarm code: 0H1 or 0LU), this control decreases the drive's output frequency to suppress the trip.

Apply this control to equipment (such as pumps) whose drive frequency drops in line with any decrease in load. If you want to drive this kind of equipment even if the drive reduces the output frequency, enable this control.

NOTE: Do not use this function with equipment whose load does not diminish with reduced drive output frequency, as it will have no effect.

Specify a combination between the output phase loss protection, input phase loss protection, and automatic carrier frequency lowering.

#### **Automatic lowering of carrier frequency**

When using a drive in a critical system or any other system where drive operation should not be interrupted, select this feature to protect the system from any failure resulting from the drive tripping due to the heat sink overheating (OH1) or overload (OLU), abnormally high ambient temperature, or a cooling mechanism failure. This feature lowers the drive frequency before the drive enters the alarm mode. However, the level of motor noise may increase.

#### **Input phase loss protection (L<sub>rip</sub>)**

The drive will enter the alarm mode and issue an alarm (L<sub>rip</sub>) if a phase loss is detected in the three-phase input power source.

Do not enable this protection with drives with single-phase input, as it is not applicable.

When operating a drive with three-phase input with a single phase for testing purposes, this protection may be disabled, but only if the load can be reduced.

#### **Output phase loss protection (OPL)**

The drive will enter the alarm mode activated by the output phase loss protection, and issue the alarm OPL if it detects an output phase loss while it is running.

If a magnetic contactor that has been inserted in the drive output circuits switches off when the drive is running, however, this protection will not be activated.

# 6. Troubleshooting

## 6.1 Before Proceeding with Troubleshooting

### WARNING

If any of the protective functions have been activated, first eliminate the cause. Then, after checking that the all run commands are set to OFF, reset the alarm. Note that if the alarm is reset while any run commands are set to ON, the drive may supply power to the motor and cause it to start.

#### Injury may occur.

- Even though the drive has interrupted power to the motor, if voltage is applied to the main circuit power input terminals L1/R, L2/S and L3/T (L1/L and L2/N for 1-phase voltage input), then voltage may also be present at the drive output terminals U, V, and W.
- Some residual electric charge may remain in the intermediate dc circuit capacitor even after the power is turned off. It may take some time until the intermediate dc circuit voltage reaches a safe level. Before touching any part of the circuit, wait for at least five minutes after the power has been turned off, and verify that the dc voltage between main circuit terminals P (+) and N (-) is less than 25 V using a multimeter.

#### Electric shock may occur.

Follow the procedure below to resolve any problems.

- (1) If a connection has been performed incorrectly, refer to Chapter 2, Subsection 2.3.4 “Wiring for Main Circuit Terminals and Ground Terminals.”
- (2) Is an alarm code displayed on the LED monitor?



Quick reference table of alarm codes

Alarm code	Name	Refer to	Alarm code	Name	Refer to
OC1	Overcurrent protection	p.6-10	OH4	PTC thermistor for motor protection	p.6-15
OC2			dbH	Overheat protection for braking resistor	p.6-16
OC3			OL1	Electronic thermal overload relay	p.6-17
OU1	Overvoltage protection	p.6-11	OLU	Overload protection	p.6-17
OU2			Er1	Memory error	p.6-18
OU3			Er2	Remote keypad communications error	p.6-19
LU	Undervoltage protection	p.6-12	Er3	CPU error	p.6-19
L <sub>inv</sub>	Input phase loss protection	p.6-13	Er6	Operation protection	p.6-20
OPL	Output phase loss protection	p.6-13	Er8	RS485 communications error	p.6-20
OH1	Overheat protection for heat sink	p.6-14	ErF	Data save error during undervoltage	p.6-21
OH2	External alarm input	p.6-15			

## 6.2 If no alarm code appears on the LED monitor

### 6.2.1 Motor is running abnormally

#### [1] The motor does not rotate.

Possible Causes	What to Check and Suggested Measures
(1) No power supplied to the drive.	CHECK Check input voltage, output voltage and interphase imbalance. SUGGESTED ACTIONS – Connect a molded case circuit breaker, a ground fault circuit interruptor (with the exception of those exclusively designed for protection from ground faults) or a magnetic contactor. – Check for voltage drop, phase loss, poor connections, or poor contacts, and fix them if necessary.
(2) No forward/reverse operation command was input, or both the commands were inputted simultaneously (external signal operation).	CHECK Check input status of the forward/reverse command using Menu #4 “I/O checking.” SUGGESTED ACTIONS – Input a run command. – Set either the forward or reverse operation command to OFF if both commands are being inputted. – Correct the assignment of commands (FWD) and (REV) to function codes E98 and E99. – Connect the external circuit wires to control circuit terminals [FWD] and [REV] correctly. – If the printed circuit board is malfunctioning, replace it.
(3) No indication of rotation direction (keypad operation).	CHECK Check input status of the forward/reverse rotation direction command using Menu #4 “I/O checking.” SUGGESTED ACTIONS – Input the rotation direction (F02=0), or select the keypad operation with which the rotation direction is fixed (F02=2 or 3).
(4) The drive could not accept any run commands from the keypad because it was not in Run mode.	CHECK Check which operation mode the drive is in. SUGGESTED ACTIONS – Make a transition from existing mode to Run mode.
(5) A run command with higher priority than the one attempted was active, and the run command was stopped.	CHECK Check the higher priority run command with using Menu #2 “Data checking” and Menu #4 “I/O checking,” while referring to the block diagram of the drive command generator*. *Refer to Chapter 4 in the AF-300 Mini User’s Manual. SUGGESTED ACTIONS – Change any incorrect function code data settings (e.g., cancel the higher priority run command).
(6) The set frequency was set to the same or lower than the value of the starting or stop frequency.	CHECK Check that a frequency command has been input, using Menu #4 “I/O checking.” SUGGESTED ACTIONS – Set the value of the set frequency to the same or higher than that of the starting or stop frequency (F23 or F25). – Reconsider the starting and stop frequencies (F23 and F25), and if necessary, change to lower values. – Inspect the frequency command devices, signal converters, switches or relay contacts. Replace any that are faulty. – Connect the external circuit wires correctly to terminals [13], [12], [11] and [C1].
(7) A run command with higher priority than the one attempted was active and the set frequency was set to the same or lower than the value of the starting or stop frequency.	CHECK Check the higher priority run command using Menu #2 “Data checking” and Menu #4 “I/O checking,” while referring to the block diagram of the drive command generator. *Refer to Chapter 4 in the AF-300 Mini User’s Manual. SUGGESTED ACTIONS – Correct any incorrect function code data settings (e.g. cancel the higher priority run command).
(8) The peak and minimum frequencies for the frequency limiters were set incorrectly.	CHECK Check the data for function codes F15 and F16. SUGGESTED ACTIONS – Change the peak and minimum frequencies (F15 and F16) to the correct ones.



Possible Causes	What to Check and Suggested Measures
(9) The coast-to-stop command was enabled	CHECK Check the data of function codes E01, E02, E03, E98 and E99 using Menu #2 "Data checking" and the input signal status with Menu #4 "I/O checking." SUGGESTED ACTIONS – Disable the coast-to-stop command setting.
(10) Broken wire, incorrect connection or poor contact with the motor.	CHECK Check if the output current and connection are correct. SUGGESTED ACTIONS – Repair the wires to the motor, or replace them.
(11) Overload	CHECK Check that the output current is not too large. SUGGESTED ACTIONS – Reduce the load (e.g. operate the mechanical brake correctly).
(12) Torque generated by the motor was insufficient.	CHECK Check that the motor starts running if the value of torque boost (F09) is increased. SUGGESTED ACTIONS – Increase the value of torque boost (F09) and try to run the motor. CHECK Check the data of function codes F04, F05, H50, and H51. SUGGESTED ACTIONS – Change the V/f pattern to match the motor's characteristics.

**[2] The motor rotates, but the speed does not increase.**

Possible Causes	What to Check and Suggested Measures
(1) The maximum frequency was set to too low a value.	CHECK Check the data of function code F03. SUGGESTED ACTIONS – Reset the maximum frequency (F03) to a correct value.
(2) The peak frequency of the frequency limiter was set to too low a value.	CHECK Check the data of function code F15. SUGGESTED ACTIONS – Reset the peak frequency of the frequency limiter (F15) to a correct value.
(3) The set frequency was set to too low a value.	CHECK Check the signals for the set frequency from the control circuit terminals using Menu #4 "I/O checking." SUGGESTED ACTIONS – Increase the set frequency. – If external potentiometers for frequency command, signal converter, switches, or relay contacts are malfunctioning, replace them. – Connect the external circuit wires to terminals [13], [12], [11], and [C1] correctly.
(4) A run command with higher priority than the one attempted (e.g. multi-step frequency, communications or jogging operation, etc.) was active and the set frequency was set to too low a value.	CHECK Check the higher priority run command using Menu #2 "Data checking" and Menu #4 "I/O checking," while referring to the block diagram of the drive command generator. *Refer to Chapter 4 in the AF-300Mini User's Manual. SUGGESTED ACTIONS – Correct any incorrect function code data settings (e.g. cancel the higher priority run command, etc.).
(5) The acceleration/ deceleration time was too long.	CHECK Check the data of function codes F07, F08, E10, E11 and H54. SUGGESTED ACTIONS – Change the acceleration/deceleration time to match the load.
(6) Overload	CHECK Measure the output current. SUGGESTED ACTIONS – Reduce the load (e.g. operate the mechanical brake correctly).

Possible Causes	What to Check and Suggested Measures
(7) The current limiting operation did not increase the output frequency.	CHECK Check whether the current limiting is active or not using Menu #3 "drive monitoring" and the data for the current limiting level (F44). SUGGESTED ACTIONS – Change the level of the current limiting (F44) to an appropriate value. CHECK Decrease the value of torque boost (F09), then turn the power off and back on again and check if the speed increases. SUGGESTED ACTIONS – Adjust the value of the torque boost (F09). CHECK Check the data for function codes F04, F05, H50, and H51 to ensure that the V/f pattern is right. SUGGESTED ACTIONS – Match the V/f pattern values with the motor ratings.
(8) Bias and grain set incorrectly	CHECK Check the data of function codes F18, C50, C32, C34, C37 and C39. SUGGESTED ACTIONS – Set correct data values if necessary

### [3] The motor runs in the opposite direction to the command

Possible Causes	What to Check and Suggested Measures
(1) Wiring has been connected to the motor incorrectly	CHECK Check the wiring to the motor. SUGGESTED ACTIONS – Connect terminals U, V, and W of the drive to the respective U, V, and W terminals of the motor.
(2) Incorrect connection and settings for run commands and rotation direction command (FWD) and (REV)	CHECK Check the data entered for function codes E98 and E99 and the connection to terminals [FWD] and [REV]. SUGGESTED ACTIONS – Correct the function code data and the connection.
(3) The setting for the direction of rotation via keypad operation is incorrect.	CHECK Check the data for function code F02. SUGGESTED ACTIONS – Change the data of function code F02 to 2 (forward rotation) or 3 (reverse rotation).

### [4] If speed variation (such as hunting) and current fluctuation occur at regular speed

Possible Causes	What to Check and Suggested Measures
(1) The frequency command varied.	CHECK Check the signals for the frequency command using Menu #4 "I/O checking." SUGGESTED ACTIONS – Increase the filter constants (C33 and C38) for the frequency command.
(2) An external frequency command device was used.	CHECK Check that there is no noise in the control signal wires from external sources. SUGGESTED ACTIONS – Isolate the control signal wires from the main circuit wires as far as possible. – Use shielded or twisted wires for the control signal.
(3) The slip compensation gain was too large.	CHECK Check that the motor vibration is absorbed if the slip compensation (P09) is cancelled. SUGGESTED ACTIONS – Correct or cancel the slip compensation (P09) data.

Possible Causes	What to Check and Suggested Measures
(4) The system vibrates due to a too-compliant mechanical coupling between the motor and load, or the current fluctuates due to motor characteristics.	CHECK Cancel the automatic control system (automatic torque boost, slip compensation, energy saving operation, overload prevention control, current limiting) and check that the motor vibration is suppressed (F37, P09, H70, and F43). SUGGESTED ACTIONS – Cancel the functions causing the vibration. – Adjust the data of the current oscillation suppression gain (H80). CHECK That the motor vibration is suppressed if you decrease the carrier frequency (F26) or set the sound tuning (F27) to 0 (level 0). SUGGESTED ACTIONS – Decrease the carrier frequency (F26), or cancel the sound tune (F27).

#### [5] If grating sound can be heard

Possible Causes	What to Check and Suggested Measures
(1) The carrier frequency was set to too low a value.	CHECK Check the data for function codes F26 and F27. SUGGESTED ACTIONS – Increase the carrier frequency (F26). – Make tone selection function (F27) effective and select the correct value.

#### [6] The motor does not accelerate and decelerate at the set time.

Possible Causes	What to Check and Suggested Measures
(1) The drive ran the motor by S-curve or curvilinear pattern.	CHECK Check the data for function code H07. SUGGESTED ACTIONS – Select the linear pattern.
(2) Current limiting prevented the output frequency from increasing.	CHECK That current limiting is enabled using Menu #3 “drive monitoring,” and the data for the current limiting level (F44). SUGGESTED ACTIONS – Change the current limiting level (F44) to a correct value. – Increase the acceleration and deceleration time (F07, F08, E10, and E11).
(3) Automatic deceleration was active.	CHECK Check the data for function code H69. SUGGESTED ACTIONS – Consider the use of a braking resistor. – Increase the deceleration time (F08 and E11).
(4) Overload	CHECK Measure the output current. SUGGESTED ACTIONS – Reduce the load.
(5) Torque generated by the motor was insufficient.	CHECK Check that the motor starts running if the value of the torque boost (F09) is increased. SUGGESTED ACTIONS – Increase the value of the torque boost (F09).
(6) An external frequency command device is being used.	CHECK Check that there is no noise in the external signal wires. SUGGESTED ACTIONS – Isolate the control signal wires from the main circuit wires as far as possible. – Use shielded wire or twisted wire for the control signal wires.

**[7] Power is restored after an instantaneous power failure, but the motor does not restart.**

Possible Causes	What to Check and Suggested Measures
(1) The setting of function code F14 did not make the motor restart even if the power recovered after an instantaneous power failure.	CHECK Check if an undervoltage trip occurs. SUGGESTED ACTIONS – Change the data for function code F14 to 4 or 3.
(2) The run command stayed OFF even after the power recovered.	CHECK Check if the input signal with Menu #4 “I/O checking.” SUGGESTED ACTIONS – Verify the power recovery sequence with an external circuit. If necessary, consider the use of a relay that can keep the run command on.

**6.2.2 Problems with drive settings**

**[1] If the data of function codes cannot be changed**

Possible Causes	What to Check and Suggested Measures
(1) An attempt was made to change function code data that cannot be changed when the drive is running.	CHECK Check if the drive is running using Menu #3 “drive monitoring,” and whether the data of the function codes can be changed when the motor is running (refer to the function code tables). SUGGESTED ACTIONS – Stop the motor then change the data of the function codes.
(2) The data of the function codes is protected.	CHECK Check the data of function code F00. SUGGESTED ACTIONS – Disable data protection of function codes.
(3) The “Edit enable for keypad” (WE-KP) command was not set ON after being assigned to a digital input terminal.	CHECK Check the data for function codes E01, E02, E03, E98 and E99, and the input signals using Menu #4 “I/O checking.” SUGGESTED ACTIONS – Cancel data protection of the function codes or set the “Edit enable for keypad” command ON.
(4) Intermediate dc circuit voltage was below the undervoltage detection level.	CHECK Check the DC voltage at the intermediate circuit with Menu #5 “Maintenance information,” and measure the input voltage. SUGGESTED ACTIONS – Supply power to match the drive input rating and change the data of the function codes.

**[2] The desired menu is not displayed.**

Possible Causes	Check and Measures
(1) The limiting menus function was not selected appropriately.	CHECK Check the data for function code E52. SUGGESTED ACTIONS – Change the data for function code E52 to display the desired menu.

### [3] Nothing appears on the LED monitor.

Possible Causes	What to Check and Suggested Measures
(1) No power supplied to the drive.	CHECK Check input voltage, output voltage and interphase unbalance. SUGGESTED ACTIONS – Connect a molded case circuit breaker, an ground fault circuit interruptor (with the exception of those designed for protection from ground faults only) or a magnetic contactor. – Check for voltage drop, phase loss, poor connections, or poor contacts, and fix them if necessary.
(2) The power for the control circuit did not reach a high enough level.	CHECK Check if the jumper bar has been removed between terminals P1 and P (+) or if there is poor contact between the jumper bar and the terminals. SUGGESTED ACTIONS – Connect the jumper bar to terminals P1 and P (+), or tighten the screws. Or connect a DC reactor. – Replace the drive if it is malfunctioning.

## 6.3 If an alarm code appears on the LED monitor

### [1] OC<sub>m</sub> Overcurrent protection

Problem The drive output current momentarily exceeded the overcurrent level.

OC1 Overcurrent occurred during acceleration.

OC2 Overcurrent occurred during deceleration.

OC3 Overcurrent occurred when running at a constant speed.

Possible Causes	What to Check and Suggested Measures
(1) The drive output terminals were short-circuited.	CHECK Remove the wires connected to the drive output terminals (U, V, and W) and measure the interphase resistance. Check if the resistance is too low. SUGGESTED ACTIONS – Remove the short-circuit (including replacement of the wires, relay terminals and motor).
(2) Ground faults occurred at the drive output terminals.	CHECK Remove the wires connected to the drive output terminals (U, V, and W) and perform a Megger test. SUGGESTED ACTIONS – Remove the short-circuit (including replacement of the wires, relay terminals and motor).
(3) Loads were too heavy.	CHECK Measure the motor current with a meter, and observe the current variations. Use this information to decide if the current may exceed calculated design values for your system. SUGGESTED ACTIONS – Reduce excessive load or use a larger drive.
	CHECK Observe the current variations and check if there are any sudden changes in the current. SUGGESTED ACTIONS – If there are any sudden changes, make the load variation smaller or raise the drive capacity. – Enable current limiting (H12).
(4) The value set for torque boost (F09) was too large. (F37 = 0, 1, 3, or 4)	CHECK Check that the output current decreases and that the motor does not stall if you set a lower value than the present one for F09. SUGGESTED ACTIONS – Lower the value for torque boost (F09) if the motor is not going to stall.

Possible Causes	What to Check and Suggested Measures
(5) Acceleration/ deceleration time was too short.	CHECK Check that the motor generates enough torque during acceleration/deceleration. The torque requirement is calculated from the moment of inertia of the load and the acceleration/deceleration time. SUGGESTED ACTIONS – Increase the acceleration/deceleration time (F07, F08, E10, E11, and H54). – Enable current limiting (F43). – Increase the drive capacity.
(6) Malfunction caused by noise	CHECK Check if noise control measures are appropriate (e.g., correct grounding and routing of control and main circuit wires). SUGGESTED ACTIONS – Implement noise control measures. – Enable the auto-reset function (H04).

## [2] OU<sub>m</sub> Overvoltage protection

Problem The intermediate DC circuit voltage was over the detection level of overvoltage.

OU1 Overvoltage occurs during the acceleration.

OU2 Overvoltage occurs during the deceleration.

OU3 Overvoltage occurs during running at constant speed.

Possible Causes	What to Check and Suggested Measures
(1) The power supply voltage was over the range of the drive's specifications.	CHECK Measure the input voltage. SUGGESTED ACTIONS – Decrease the voltage to within specification.
(2) The acceleration time was too short.	CHECK Check if the overvoltage alarm occurs after sudden acceleration. SUGGESTED ACTIONS – Increase the acceleration time (F07, E10, and H54). – Select the S-curve pattern (H07). – May need a braking resistor.
(3) The deceleration time was too short for the moment of inertia of load.	CHECK Recalculate the deceleration torque from the moment of inertia for load and the deceleration time. SUGGESTED ACTIONS – Increase the deceleration time (F08, E11, and H54). – Enable automatic deceleration (H69=1) so that when the intermediate dc circuit voltage exceeds the overvoltage suppression level, the drive changes deceleration time to three times longer than the set value. – Set the rated voltage at base frequency (F05) to 0 to improve braking ability. – May need a braking resistor.
(4) Loads were suddenly removed.	CHECK Check if the alarm occurs when loads are suddenly removed. Check if the drive operation suddenly changes from driving operation to braking operation. SUGGESTED ACTIONS – May need a braking resistor.
(4) Loads were suddenly removed.	CHECK Check if the alarm occurs when loads are suddenly removed. Check if the drive operation suddenly changes from driving operation to braking operation. SUGGESTED ACTIONS – May need a braking resistor.

### [3] LU Undervoltage protection

Problem Intermediate dc circuit voltage was below the undervoltage detection level.

Possible Causes	What to Check and Suggested Measures
(1) An instantaneous power failure occurred.	SUGGESTED ACTIONS – Reset the alarm. – To restart running the motor without an alarm, set F14 to a value of 4 or 5 depending on load.
(2) The power to the drive was switched back on too soon (with F14 = 1)	CHECK Only switch the drive on after the power for the control circuit has reached an appropriate level. This can be checked using the display on the LED monitor. SUGGESTED ACTIONS – Wait longer before switching the drive on.
(3) The power supply voltage did not reach the range of the drive's specifications.	CHECK Measure the input voltage. SUGGESTED ACTIONS – Increase the voltage to specification.
(4) Peripheral equipment for the power circuit malfunctioned, or the connection was wrong.	CHECK Measure the input voltage to find where the peripheral equipment malfunctioned or which connection is incorrect. SUGGESTED ACTIONS – Replace any faulty peripheral equipment, or correct any wrong connections.
(5) High inrush current of other loads connected to the same power system as the drive caused a temporary voltage drop.	CHECK Measure the input voltage and check the voltage variation. SUGGESTED ACTIONS – Reconsider the power system configuration.
(6) Inrush current caused the power voltage drop because power transformer capacity was insufficient.	CHECK Check if the alarm occurs when you switch on a molded case circuit breaker, a ground fault circuit interrupter (GFCI) or a magnetic contactor. SUGGESTED ACTIONS – Reconsider the power transformer rating.

### [4] L<sub>rm</sub> Input phase loss protection

Problem Input phase loss occurred, or rate of unbalance of interphase power voltage was large.

Possible Causes	What to Check and Suggested Measures
(1) Main circuit power input wires broken.	CHECK Measure the input voltage. SUGGESTED ACTIONS – Repair or replace the wires.
(2) The terminal screws for the main circuit power input were not tight enough.	CHECK Check if the terminal screws have become loose. SUGGESTED ACTIONS – Tighten the terminal screws to the recommended torque.
(3) Interphase unbalance rate of 3-phase voltage was too large.	CHECK Measure the input voltage. SUGGESTED ACTIONS – Connect an ac reactor (ACR) or a dc reactor (DCR) to lower the rate. – Raise the drive capacity.

Possible Causes	What to Check and Suggested Measures
(4) Cyclic overload occurred.	CHECK Measure ripple wave of intermediate dc circuit voltage. SUGGESTED ACTIONS – If the ripple is large, raise the drive capacity
(5) 1-phase voltage was supplied to the drive instead of 3-phase voltage.	CHECK Check the drive type. SUGGESTED ACTIONS – Change the drive to one for 1-phase voltage input.

## [5] OPL Output phase loss protection

Problem Output phase loss occurred.

Possible Causes	What to Check and Suggested Measures
(1) Drive output wires are broken	CHECK Measure the output current. SUGGESTED ACTIONS – Replace the output wires.
(2) Open circuit in motor windings	CHECK Measure the output current. SUGGESTED ACTIONS – Replace the motor.
(3) The terminal screws for drive output were not tight enough.	CHECK Check if any terminal screws have become loose. SUGGESTED ACTIONS – Tighten the terminal screws to the recommended torque.
(4) A 1-phase motor has been connected	SUGGESTED ACTIONS – 1-phase motors cannot be used. Note that the AF-300 Mini only drives 3-phase induction motors.

## [6] OH1 Overheat protection for heat sink

Problem Temperature around heat sink rose.

Possible Causes	What to Check and Suggested Measures
(1) Temperature around the drive exceeded that of drive specifications.	CHECK Measure the temperature around the drive. SUGGESTED ACTIONS – Lower the temperature around the drive (e.g. improve control board ventilation). – Reduce the load.
(2) Accumulated running time of the cooling fan exceeded the standard period for replacement, or the cooling fan malfunctioned.	CHECK Check the accumulated running time (E52 = 2). Refer to Chapter 3, Section 3.8 “Reading Maintenance Information.” SUGGESTED ACTIONS – Replace the cooling fan. CHECK Visually check that the cooling fan rotates normally. SUGGESTED ACTIONS – Replace the cooling fan.
(3) Air vent is blocked.	CHECK Check if there is sufficient clearance around the drive. SUGGESTED ACTIONS – Increase the clearance. CHECK Check if the heat sink is clogged. SUGGESTED ACTIONS – Clean the heat sink.



Possible Causes	What to Check and Suggested Measures
(4) Excessive load.	CHECK Measure the output current. SUGGESTED ACTIONS – Reduce the load (e.g. lighten the load before the overload protection occurs using the overload early warning (E34)). – Lower the carrier frequency (F26). – Enable the overload protection control (H70).

## [7] OH2 External alarm input

Problem External alarm was signalled (THR).

Possible Causes	What to Check and Suggested Measures
(1) An alarm function of the external equipment was activated.	CHECK Inspect external equipment operation. SUGGESTED ACTIONS – Remove the cause of the alarm.
(2) Connection has been performed incorrectly.	CHECK Check if the wire for the external alarm signal is correctly connected to the terminal to which the “Alarm from external equipment” has been assigned. SUGGESTED ACTIONS – Connect the wire for the alarm signal correctly.
(3) Incorrect settings.	CHECK Check if the “Alarm from external equipment” has been assigned to an unassigned terminal. SUGGESTED ACTIONS – Correct the assignment.

## [8] OH4 PTC thermistor for motor protection

Problem Temperature of the motor rose abnormally.

Possible Causes	What to Check and Suggested Measures
(1) Temperature around the motor exceeded that of motor specifications.	CHECK Measure the temperature around the motor. SUGGESTED ACTIONS – Decrease the temperature. – Reduce the load.
(2) Cooling system for the motor malfunctioned.	CHECK Check if the cooling system is operating normally. SUGGESTED ACTIONS – Repair or replace the cooling system.
(3) Load was too heavy.	CHECK Measure the output current. SUGGESTED ACTIONS – Reduce the load (e.g., lighten the load before overload occurs using the overload early warning (E34) function). – Lower the temperature around the motor. – Raise the carrier frequency (F26).
(4) The set activation level (H27) of the PTC thermistor for motor overheat protection was inadequate.	CHECK Check the thermistor specifications and recalculate the detection voltage. SUGGESTED ACTIONS – Reconsider the data of function code H27.
(5) A PTC thermistor and pull-up resistor were connected incorrectly or their resistance was inadequate.	CHECK Check the connections and resistance. SUGGESTED ACTIONS – Correct the connections and resistance.

Possible Causes	What to Check and Suggested Measures
(6) The value set for the torque boost (F09) was too high.	CHECK Check the data of function code F09 and readjust the data so that the motor does not stall even if you set a lower value. SUGGESTED ACTIONS – Change the data for this function code.
(7) The V/f pattern did not match the motor.	CHECK Check if the base frequency (F04) and rated voltage at base frequency (F05) match the values on the motor nameplate. SUGGESTED ACTIONS – Match the function code data to the motor nameplate values.

### [9] dbH Overheat protection for braking resistor

Problem Thermal protection for braking resistor activated.

Possible Causes	What to Check and Suggested Measures
(1) Braking load was too heavy.	CHECK Recalculate the relation between the braking load and braking capacity. SUGGESTED ACTIONS – Reduce the braking load. – Revise the braking resistor in order to improve braking ability. Resetting the data of function codes F50 and F51 is also required.
(2) The deceleration time was too short.	CHECK Recalculate the required deceleration torque and time from the moment of inertia for the load and the deceleration time. SUGGESTED ACTIONS – Increase the deceleration time (F08, E11, and H54). – Use a bigger braking resistor in order to improve braking ability. Resetting the data for function codes F50 and F51 is also required.
(3) Incorrect data values set for function codes F50 and F51.	CHECK Check the braking resistor specifications. SUGGESTED ACTIONS – Change the data for function codes F50 and F51 as necessary.

NOTE: The drive estimates braking resistor overheating by monitoring load, not by measuring actual temperature. If the resistor is used more frequently than the data values for function codes F50 and F51 indicate, the alarm may be triggered even if the braking resistor does not appear to be hot. If the resistor is used to the limit of its capacity, the data values for function codes F50 and F51 must be changed and the surface temperature of the resistor checked.

### [10] OL1 Electronic thermal overload relay

Problem Electronic thermal function for motor overload detection activated.

Possible Causes	What to Check and Suggested Measures
(1) Excessive load.	CHECK Measure the output current. SUGGESTED ACTIONS – Reduce the load (e.g. lighten the load before overload occurs using the overload early warning (E34)).
(2) The acceleration/ deceleration time was too short.	CHECK Check that the motor generates enough torque for acceleration/deceleration. This torque is calculated using the moment of inertia for the load and the acceleration/deceleration time. SUGGESTED ACTIONS – Lengthen the acceleration/ deceleration time (F07, F08, E10, E11 and H54).

Possible Causes	What to Check and Suggested Measures
(3) The characteristics of electronic thermal did not match those of the motor overload.	CHECK Check the motor characteristics. SUGGESTED ACTIONS – Reconsider the data of function codes P99, F10 and F12. – Use an external thermal relay.
(4) Activation level for the electronic thermal relay was inadequate.	CHECK Check the continuous allowable current of the motor. SUGGESTED ACTIONS – Reconsider and change the data for function code F11.



## [11] OLU Overload protection

Problem            Temperature inside drive rises abnormally.

Possible Causes	What to Check and Suggested Measures
(1) Temperature around the drive exceeds drive specifications.	CHECK Measure the temperature around the drive. SUGGESTED ACTIONS – Lower the temperature (e.g. improve control board ventilation). – Reduce the load.
(2) The service life of the cooling fan has expired or the cooling fan malfunctioned.	CHECK Check the accumulated running time of cooling fan (E52 = 2). Refer to Chapter 3, Section 3.8 “Reading Maintenance Information.” SUGGESTED ACTIONS – Replace the cooling fan. CHECK Visually check that the cooling fan is turning normally. SUGGESTED ACTIONS – Replace the cooling fan.
(3) Air vent blocked.	CHECK Check if there is sufficient clearance around the drive. SUGGESTED ACTIONS – Increase the clearance. CHECK Check if the heat sink is clogged. SUGGESTED ACTIONS – Clean the heat sink.
(4) Excessive load.	CHECK Measure the output current. SUGGESTED ACTIONS – Reduce the load (e.g. lighten the load before overload occurs using the overload early warning (E34)). – Decrease the carrier frequency (F26). – Enable overload protection control (H70).
(5) Acceleration/ deceleration time too short.	CHECK Recalculate the required acceleration/deceleration torque and time using the moment of inertia for the load and the deceleration time. SUGGESTED ACTIONS – Lengthen the acceleration/deceleration time (F07, F08, E10, E11 and H54).
(6) The wires to the motor are too long resulting in excessive leakage current	CHECK Measure leakage current. SUGGESTED ACTIONS – Connect an output circuit filter (OFL).

## [12] Er1 Memory error

Problem Error occurred in writing the data to the memory in the drive.

Possible Causes	What to Check and Suggested Measures
(1) Power supply turned off while drive was writing data (especially initializing data), and residual control circuit voltage was not high enough to enable writing of data.	CHECK Check whether pressing the  key resets the alarm after the function code data are initialized by setting the data for function code H03 to 1. SUGGESTED ACTIONS – Return the initialized function code data to their previous settings, then restart the operation.
(2) High intensity noise was applied to the drive while data (especially initializing data) was being written.	CHECK Check if appropriate noise control measures have been implemented (e.g. correct grounding and routing of control and main circuit wires). Alternatively, perform the same check as described in (1) above. SUGGESTED ACTIONS – Improve noise control. Alternatively, return the initialized function code data to their previous settings, then restart the operation.
(3) The CPU did not operate normally.	CHECK Initialize the function code data by setting H03 to 1, then reset the alarm by pressing the  key and check that the alarm is triggered. SUGGESTED ACTIONS – Replace malfunctioning printed circuit board (PCB).

## [13] Er2 Remote keypad communications error

Problem A communications error occurred between the remote keypad and the drive.

Possible Causes	What to Check and Suggested Measures
(1) Break in the communications cable or poor contact.	CHECK Check continuity of the cable, contacts and connections. SUGGESTED ACTIONS – Replace the cable.
(2) High intensity noise was applied to the drive.	CHECK Check if appropriate noise control measures have been implemented (e.g. correct grounding and routing of control and main circuit wires). SUGGESTED ACTIONS – Improve noise control.
(3) The remote keypad malfunctioned.	CHECK Check that alarm Er2 does not occur if you connect another remote keypad to the drive. SUGGESTED ACTIONS – Replace the remote keypad
(4) The RS485 communications card malfunctioned.	CHECK Check that alarm Er2 does not occur even if you connect another remote keypad to the drive. SUGGESTED ACTIONS – Replace the card.



### [14] Er3 CPU error

Problem A CPU error (e.g. erratic CPU operation) occurred.

Possible Causes	What to Check and Suggested Measures
(1) High intensity noise was applied to the drive.	CHECK Check if appropriate noise control measures have been implemented (e.g. correct grounding and routing of control and main circuit wires). SUGGESTED ACTIONS – Improve noise control.
Possible Causes	What to Check and Suggested Measures
(2) The printed control circuit board in the drive malfunctioned.	SUGGESTED ACTIONS – Replace the board.

### [15] Er6 Operation protection

Problem An error occurred due to incorrect operation of the motor.

Possible Causes	What to Check and Suggested Measures
(1) The  key was pressed when H96 = 1 or 3.	CHECK Change the setting for H96 so that the STOP key priority function is invalid to ensure that the drive does not operate unexpectedly.
(2) The start check function was activated when H96 = 2 or 3.	CHECK Check that Er6 occurs when: – The power is switched ON. – An alarm is released (the  key is pressed) – The link command (LE) has switched the drive operations. SUGGESTED ACTIONS – Reconsider the running sequence to avoid input of the run command when Er6 has occurred. – Change the setting for H96 so that the STOP key priority function is invalid to ensure the drive does not operate unexpectedly. (To reset the alarm, turn the run command off.)

### [16] Er8 RS485 communications error



Problem A communications error occurred during RS485 communications.

Possible Causes	What to Check and Suggested Measures
(1) High-level controllers (e.g. PLCs and personal computers) did not operate due to incorrect settings and/or defective software/hardware.	CHECK Check the controllers. SUGGESTED ACTIONS – Remove the cause of the controller error.
(2) Relay converters (e.g. RS232C/RS485 converter) did not operate due to incorrect connections and settings, and defective hardware.	CHECK Check the converter (e.g. check for poor contact). SUGGESTED ACTIONS – Change the various converter settings, reconnect the wires, or replace hardware as appropriate.
(3) Broken communications cable or poor contact.	CHECK Check continuity of the cable, contacts and connections. SUGGESTED ACTIONS – Replace the cable.

Possible Causes	What to Check and Suggested Measures
(4) Even though a response error detection time (y08) has not been set, communications did not occur cyclically.	CHECK Check the high-level controllers. SUGGESTED ACTIONS – Change the settings of high-level controller software, or make the no response error detection time invalid (y08 = 0).
(5) High intensity noise was applied to the drive.	CHECK Check if appropriate noise control measures have been implemented (e.g. correct grounding and routing of control and main circuit wires). SUGGESTED ACTIONS – Improve noise control. – Improve measures against noise from high-level controllers. – Replace the relay converter with a recommended insulated converter.
(6) Incompatible communications protocols between the drive and high-level controllers.	CHECK Compare the settings of the y codes (y01 to y10) with those of the high-level controllers. SUGGESTED ACTIONS – Correct the any settings which do not match.
(7) The RS485 communications card malfunctioned.	SUGGESTED ACTIONS – Replace the card.

### [17] ErF Data save error during undervoltage

**Problem** The drive was unable to save data such as the frequency commands, timer, and PID process commands set through the keypad when the power was switched off.

Possible Causes	What to Check and Suggested Measures
(1) Control circuit voltage dropped suddenly when power was turned off while data was being saved, because the intermediate dc circuit capacitor was rapidly discharged.	CHECK Check how long it takes for the intermediate dc circuit voltage to drop to the preset voltage when the power is turned off. SUGGESTED ACTIONS – Remove whatever is causing the rapid discharge. After pressing the  key and releasing the alarm, reset the data (such as the frequency commands, timer, and PID process commands) set with the keypad to the correct settings, and then restart the motor.
(2) High intensity noise was applied to the drive while data was being written when the power was turned off.	CHECK Check if appropriate noise control measures have been implemented (e.g. correct grounding and routing of control and main circuit wires). SUGGESTED ACTIONS – Improve noise control. Press the  key to release the alarm, then reset the data (e.g. frequency commands, timer, and PID process commands) set through the keypad to the correct settings. Restart the motor.
(3) The CPU did not operate normally.	CHECK Check if ErF occurs each time the power is switched off. SUGGESTED ACTIONS Replace the malfunctioning printed circuit board (PCB).

## 7. Maintenance and Inspection

To avoid failures and assure reliable long-term operation, make daily and periodic inspections. Take the following precautions while performing any maintenance work.

### WARNING

The intermediate dc circuit capacitor may retain its charge for some time after power is turned off. Therefore it may take some time until the intermediate dc circuit voltage falls to a safe level. Do not open the control circuit terminal block cover for at least 5 minutes after the power has been turned off. Then remove the control circuit and main circuit terminal block covers and before starting any maintenance and inspection, use a multimeter verify that the dc voltage between main circuit terminals P (+) and N (-) does not exceed a safe level (<25 V).

#### Electric shock may occur.

- Maintenance, inspection, and parts replacement should be carried out only by authorized persons.
- Remove watches, rings and other metallic materials before starting work.
- Use insulated tools.
- Never attempt to modify the drive.

#### Electric shock or injuries could occur.

### 7.1 Daily Inspection

Without removing the covers while the drive operates or while it is turned on, perform an external visual inspection for operating abnormalities.

- Check that the drive is performing to specification as expected.
- Check that the operating environment conforms to Chapter 2, Section “Operating Environment.”
- Check that the LED monitor displays normally.
- Check for abnormal noise, odor, or excessive vibration.
- Check for signs of overheating (such as discoloration) and for other defects.

### 7.2 Periodic Inspection

Perform periodic inspection using the list items of Table 7.1. Stop the motor, turn the drive off and remove the control and main circuit terminal block covers to perform periodic inspection.

Table 7.1 List of Periodic Inspections

Check part	Check item	How to inspect	Evaluation criteria
Environment	1) Check the ambient temperature, humidity, vibration and atmosphere (dust, gas, oil mist, or water drops). 2) Check if tools or other foreign matter or dangerous objects are left around the equipment.	1) Check visually or measure using suitable test instruments. 2) Visual inspection	1) Standard specifications must be met. 2) No foreign or dangerous objects present.
Voltage	Check if the voltages of the main and control circuit are correct.	Measure the voltages using a multimeter or similar.	The standard specification must be satisfied.
Keypad	1) Check if the display is clear. 2) Check for missing elements in the display characters.	1), 2) Visual inspection	1), 2) The display can be read and there is no fault.

Table 7.1 List of Periodic Inspections

Check part		Check item	How to inspect	Evaluation criteria
Structure such as frame and cover		1) Abnormal noise and excessive vibration 2) Loose bolts 3) Deformation and breakage 4) Discoloration and deformation caused by overheat 5) Check for dirt and dust.	1) Visual and audible inspection 2) Retighten. 3), 4), 5) Visual inspection	1), 2), 3), 4), 5) No abnormalities
Main circuit	Common	1) Check if bolts and screws are tight and not missing. 2) Check the devices and insulators for deformation, cracks, breakage and discoloration caused by overheat and deterioration. 3) Check for dirt and dust.	1) Retighten. 2), 3) Visual inspection	1), 2), 3) No abnormalities
	Conductor and wire	1) Check the conductor for discoloration and distortion caused by overheat. 2) Check the sheath of the cable for cracks and discoloration.	1), 2) Visual inspection	1), 2) No abnormalities
	Terminal block	Check that the terminals are not damaged.	Visual inspection	No abnormalities
	Filtering capacitor (Note 1)	1) Check for electrolyte leakage, discoloration, cracks and swelling of the case. 2) Check if the safety valve does not protrude remarkably. 3) Measure the capacitance if necessary.	1), 2) Visual inspection 3) Measure discharge time with capacitance probe.	1), 2) No abnormalities 3) The discharge time is shorter than time specified by the replacement manual.
	Resistor	1) Check for odor caused by overheating and cracked insulator. 2) Check for broken wire.	1) Smelling and visual inspection 2) Visual inspection or measurement with multimeter under disconnection of one lead	1) No abnormalities 2) Within $\pm 10\%$ of displayed resistance
	Transformer and reactor	Check for abnormal noise or odor.	Hearing, visual and smelling inspection	No abnormalities
	Magnetic contactor and relay	1) Check for chattering during operation. 2) Check for rough contacts.	1) Hearing inspection 2) Visual inspection	1), 2) No abnormalities
Control circuit	Printed circuit board (Note 1)	1) Check for loose screws and connectors. 2) Check for odor and discoloration. 3) Check for cracks, breakage, deformation and corrosion. 4) Check the capacitors for electrolyte leaks and deformation.	1) Retighten. 2) Smelling and visual inspection 3), 4) Visual inspection	1), 2), 3), 4) No abnormalities
Cooling system	Cooling fan (Note 1)	1) Check for abnormal noise and excessive vibration. 2) Check for loose bolts. 3) Check for discoloration caused by overheat.	1) Hearing and visual inspection, or turn manually (be sure to turn the power off). 2) Retighten. 3) Visual inspection	1) Smooth rotation 2), 3) No abnormalities
	Ventilation path	Check the heat sink, intake and exhaust ports for clogging and foreign matter.	Visual inspection	No abnormalities

(Note 1) The judgement level of part replacement interval with Menu #5 Maintenance information is used as a guide. Determine the replacement interval on the basis of the standard replacement years. (See page 7-8.)

If the drive is stained, wipe it off with a chemically neutral cloth to remove dust, use a vacuum cleaner.



## Estimation of service life using maintenance information

Menu #5 “Maintenance Information” in Program mode can be used to display the recommended time for replacement of the intermediate dc circuit capacitor, electrolytic capacitors on the printed circuit board, and cooling fan.

When operating time exceeds the early warning level, an early warning signal is output to any external device through terminal [Y1] (function code E20). When any replacement exceeds the recommended time, terminal [Y1] also outputs an ON signal.)

Table 7.2 Parts Replacement Time Estimation with Menu #5 “Maintenance Information”

Parts to be replaced	Judgement level
Intermediate dc circuit capacitor	85% or lower of the capacitance than that of the factory setting
Electrolytic capacitor on the printed circuit board	61,000 hours or longer as accumulated run time
Cooling fan (Applicable motor rating: 2 to 5 hp)	61,000 hours or longer as accumulated run time (Assumed life of cooling fan at ambient drive temperature of 40 °C)

### (1) Intermediate dc circuit capacitor

Determine the capacitance of the intermediate dc circuit capacitor as follows:

Capacitance is displayed as a reduction ratio (%) of the initial value written to the drive memory before shipment.

#### Capacitance measurement procedure

- 1) Remove the RS485 communications card (option) from the drive if it is mounted. Disconnect the dc bus link circuit to other drives from terminals P (+) and N (-) of the main circuit if any. A dc reactor (option) or braking resistor (option) need not be disconnected. Keep the ambient temperature at  $25 \pm 10^{\circ}\text{C}$ .
- 2) Turn off the digital inputs (FWD, REV, and X1 to X3) at the control terminals.
  - If an external potentiometer is connected, to terminal [13], remove it.
  - Set the data of function codes E20 and E27 so that the transistor output [Y1] or relay output [30A, B, C] do not come ON while the drive power is turned off. (The recommended settings are to assign normal logic signal (RUN) and (ALM) to terminals [Y1] and [30A, B, C] respectively.
- 3) Turn the drive power on.
- 4) Check that the cooling fan rotates and the drive is at a stop.
- 5) Turn the main power supply off. Start measuring the capacitance of intermediate dc circuit capacitor.
- 6) After the LED monitor goes completely dark, turn the main power supply on again.
- 7) Select Menu #5 “Maintenance information” in Program mode, and check the reduction ratio (%) of the capacitance of the intermediate dc circuit capacitor.

### (2) Electrolytic capacitors on the printed circuit boards

The drive counts hours for which the power has been applied to the control circuit. The accumulated time will be multiplied by the life constant depending on the temperature inside the drive, and displayed on the LED monitor. According to the displayed hours, determine when capacitors should be replaced. The display unit is 1000 hours.

### (3) Cooling fan

The drive accumulates hours for which the cooling fan has run. The display unit is 1000 hours.

The accumulated time should be used just a guide, since the actual service life will be significantly affected by temperature and operating environment.

### 7.3 Measurement of Electrical Values in Main Circuit

Because the voltage and current of the power supply (input) of the main circuit of the drive and the output (motor) include harmonic components, the indicated values vary according to the type of meter used to measure them. Use meters indicated in Table 7.3 when measuring for commercial frequencies.

The power factor cannot be measured by a commercially available power factor meter that measures the phase difference between the voltage and current. To obtain the power factor, measure the power, voltage and current on each of the input and output sides and calculate using the following formula.







- 3-phase input

$$\text{Power factor} = \frac{\text{Electric power (W)}}{\sqrt{3} \text{ voltage (V)} \times \text{Current (A)}} \times 100\%$$

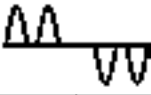
- 1-phase input

$$\text{Power factor} = \frac{\text{Electric power (W)}}{\sqrt{3} \text{ voltage (V)} \times \text{Current (A)}} \times 100\%$$

Table 7.3 Meters for Measurement of Main Circuit

Item	Input (power supply) side			Output (motor) side			Intermediate dc circuit voltage (P (+)-N (-))
waveform	Voltage 		Current 	Voltage 		Current 	
Name of meter	Ammeter AR, AS, AT	Voltmeter VR, VS, VT	Wattmeter WR, WT	Ammeter AU, AV, AW	Voltmeter VU, VV, VW	Wattmeter WU, WW	DC voltmeter V
Type of meter	Moving iron type	Rectifier or moving iron type	Digital power meter	Digital power meter	Digital power meter	Digital power meter	Moving coil type
Symbol of meter			-	-	-	-	

NOTE: When output voltage is measured by a rectifier type voltmeter, errors may be occur or the voltmeter may burn out. To measure with higher accuracy, use a digital ac power meter.

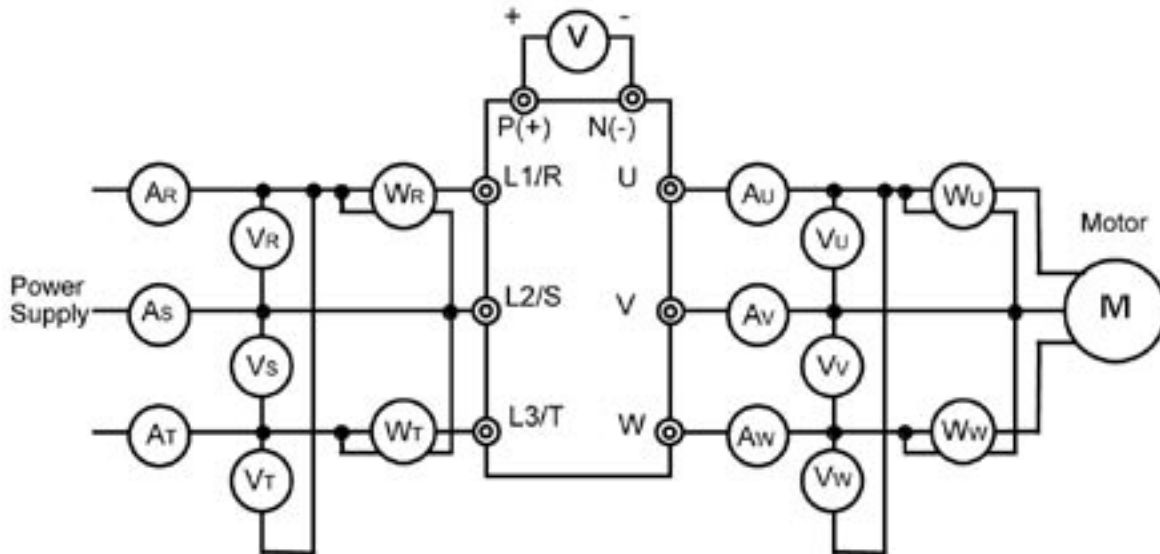

Figure 7.1 Connection of Meters

## 7.4 Insulation Test

Because an insulation test is performed in the factory before shipment, avoid a Megger test.

If a Megger test is unavoidable, follow the procedure below. Caution: an incorrect test procedure will damage the drive.

A dielectric strength test will also damage the drive if the wrong test procedure is used. If a dielectric strength test is necessary, contact the shop where you bought the product, or GE Fuji.

### (1) Megger test of main circuit

- 1) Use a 500 Vdc Megger, and be sure to shut off the main power supply during measurement.
- 2) If the test voltage leaks to the control circuit due to the wiring, disconnect all the control wiring.
- 3) Connect the main circuit terminals using a common cable as shown in Figure 7.2.
- 4) The Megger test must be limited to across the common line of the main circuit and the ground terminal (G).
- 5) 5 MΩ or a larger value displayed at the Megger indicates a correct state. (The value is for a discrete drive.)

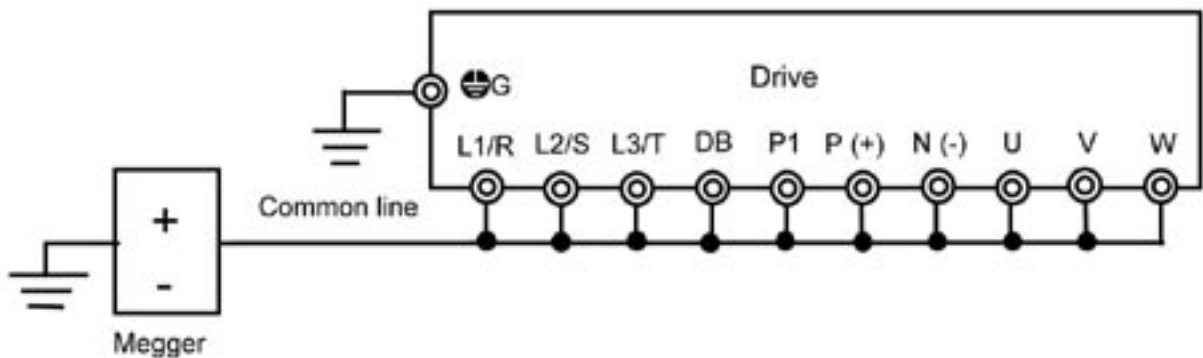

Figure 7.2 Megger Test

### (2) Dielectric strength test of control circuit

Do not perform a Megger test or dielectric strength test for the control circuit. Prepare a high resistance range tester for the control circuit.

- 1) Disconnect all the external wiring from the control circuit terminals.
- 2) Perform a continuity test to the ground. 1 MΩ or a larger measurement indicates a correct state.

### (3) Dielectric strength test of main circuit and sequence control circuit

Disconnect all the drive terminals so that the test voltage is not applied.

## 7.5 List of Periodical Replacement Parts

Each part of the product has its own service life that will vary according to the environmental and operating conditions. It is recommended that the following parts be replaced as specified below.

When the replacement is necessary, contact your dealer where you purchased the product, or GE Fuji.

Table 7.4 Replacement Parts

Part name	Standard replacement intervals
Cooling fan	5 years
Intermediate dc circuit capacitor	5 years
Electrolytic capacitor on the printed circuit board	7 years

## **7.6 Inquiries about Product and Warranty**

---

The purpose of this section is to provide specific instructions to the user of the standard drive referenced in this book regarding warranty administration and how to obtain assistance on both in-warranty and out-of-warranty equipment.

If assistance is required to determine warranty status, identify defective parts, or obtain the name of your local distributor, call:

1501 Roanoke Blvd.

Salem, VA 24153-6492 USA

Phone: + 1 888 GE4 SERV (888 434 7378, United States)

+ 1 540 378 3280 (International)

Fax: + 1 540 387 8606 (All)

("+" indicates the international access code required when calling from outside of the USA.)

### **Warranty Coverage**

The warranty covers all major parts of the drive such as the main printed circuit boards, transistor modules, etc.

"Warranty period is 12 months after installation or 18 months after shipment from the Company, whichever occurs first."

However, the guarantee will not apply in the following cases, even if the guarantee term has not expired:

1. Damage was caused by incorrect use or inappropriate repair or modification.
2. The product was used in an environment outside the standard specified range.
3. Damage was caused by dropping the product after purchase or occurred during transportation.
4. Damage was caused by an earthquake, fire, flooding, lightning, abnormal voltage, or other natural calamities and secondary disasters.

Before calling the number at left to determine warranty status, the drive serial number will be required. This is located on the drive nameplate. If the drive is still under warranty, further information will be required per the "In-Warranty Failure Checklist" shown on page 7-7 of this Start-up Guide.

### **Out-of Warranty Procedures**

When the defective part has been identified, contact your local authorized GE standard drives distributor to order replacement parts.

### **Motors**

Motor repairs on General Electric motors are generally handled by GE Authorized Electric Motor Servicenters or GE Apparatus Service Shops. For specific instructions on your motor, call the distributor from which it was purchased and be prepared to furnish complete nameplate data.

### In-Warranty Failure Checklist

To assist with warranty troubleshooting, the following information is required. This data is needed to evaluate the cause in an effort to eliminate any further failures.

Model No.: \_\_\_\_\_

Serial No.: \_\_\_\_\_

Start-Up Date: \_\_\_\_\_

Failure Date: \_\_\_\_\_

Status When Failure Occurred (check one):

Power-Up \_\_\_\_\_ Running \_\_\_\_\_ Accel \_\_\_\_\_ Decel \_\_\_\_\_

Explanation of Failure \_\_\_\_\_

Application Information (check Yes or No)

Input Transformer: Yes \_\_\_\_\_ No \_\_\_\_\_

If Yes: KVA \_\_\_\_\_

L1 Volts \_\_\_\_\_ L2 Volts \_\_\_\_\_ L3 Volts \_\_\_\_\_

Power Factor Correction Capacitors: \_\_\_\_\_ Yes \_\_\_\_\_ No \_\_\_\_\_

If Yes: Microfarad \_\_\_\_\_

Other Equipment on Same Power Yes \_\_\_\_\_ No \_\_\_\_\_

If Yes, what?

Line Reactor on Input Yes \_\_\_\_\_ No \_\_\_\_\_

Input Starter Yes \_\_\_\_\_ No \_\_\_\_\_

Output Starter Yes \_\_\_\_\_ No \_\_\_\_\_

Motor Overloads Yes \_\_\_\_\_ No \_\_\_\_\_

Control Terminals Used (circle if used)

Y1	Y1E	FMA	C1	PLC	X1	X2	X3
----	-----	-----	----	-----	----	----	----

11	12	13	11	CM	FWD	REV	CM
----	----	----	----	----	-----	-----	----

30A	30B	30C
-----	-----	-----

Function Codes Different From Factory Settings

Function Code	Setting	Function Code	Setting

Failure Message (see Section 4)

Latest Fault \_\_\_\_\_ Previous Faults: \_\_\_\_\_ No Message \_\_\_\_\_

Hz \_\_\_\_\_ 1. \_\_\_\_\_

A \_\_\_\_\_ 2. \_\_\_\_\_

V \_\_\_\_\_ 3. \_\_\_\_\_

After all of the Checklist information is acquired, contact the following number for assistance: (540) 387-5739 or (800) 533-5885

When returning failed parts, reference # on the shipping documents that came with the replacement parts and ship failed parts to GE Fuji Drives.

# ***Notes***

## 8. Specifications

### 8.1 Standard Models

#### 1) IP20 type 3-phase 230V/460V series

Item		Specifications															
Input power source		3-phase 230V class							3-phase 460V class								
Type		F12	F25	F50	001	002	003	005	F50	001	002	003	005				
6KXC123 X9 **: 230V class																	
6KXC143 X9 **: 460V class																	
Nominal applied motor *1		[hp]	1/8	1/4	1/2	1	2	3	5	1/2	1	2	3	5			
		[kW]	0.1	0.2	0.4	0.75	1.5	2.2	3.7	0.4	0.75	1.5	2.2	3.7			
Rated capacity *2		[kVA]	0.31	0.59	1.1	1.9	3.1	4.3	6.7	1.1	1.9	2.9	4.3	7.1			
Rated voltage *3		[V]	3-phase 200V/50 Hz, 200, 220, 230V/60 Hz							3-phase 380,400, 415V/50 Hz, 380, 400, 440, 460V/60 Hz							
Rated current [A]		High carrier (4-15 kHz)	0.7	1.4	2.5	4.2	7.0	10.0	16.5	1.5	2.5	3.7	5.5	9.0			
		Low carrier (-3 kHz)	0.8	1.5	3.0	5.0	8.0	11.0	17.0								
Overload capability		150% of rated current for 1 min, 200% of rated current for 0.5 s															
Rated frequency		50, 60 Hz															
Phase, voltage, frequency		3-phase, 200 to 240V, 50/60 Hz							3-phase, 380 to 480V, 50/60 Hz								
Voltage/frequency variations		Voltage: +10 to -15% (Voltage unbalance *8: 2% or less) Frequency: +5 to -5%															
Momentary voltage dip capability *4		As long as input voltage is 165V or above the drive continues operation. If it drops below 165V, the drive operates for 15 ms.							As long as input voltage is 300V or more, the drive continues operation. If it drops below 300V, the drive operates for 15 ms.								
Rated current (with DCR) *9 [A]		(with DCR)	0.57	0.93	1.6	3.0	5.7	8.3	14.0	0.85	1.6	3.0	4.4	7.3			
		(without DCR)	1.1	1.8	3.1	5.3	9.5	13.2	22.2	1.7	3.1	5.9	8.2	13.0			
Required power supply Capacity *5		[kVA]	0.3	0.4	0.6	1.1	2.0	3.0	4.9	0.6	1.1	2.0	2.9	4.9			
Braking		Torque *6 [%]	150		100		50		30		100		50		30		
		Torque *7 [%]	-		150						150						
DC injection braking		Starting frequency: 0.0 to 60.0 Hz, braking time: 0 to 30.0 s, braking level: 5 to 100% of rated current															
Conformity to safety standards		UL508C, C22.2No.14, EN50178:1997															
Enclosure (IEC60529)		IP20															
Cooling method		Natural cooling				Fan cooling				Natural cooling				Fan cooling			
Weight [lbs]		1.3	1.3	1.3	1.5	3.7	3.7	5.1	2.4	2.6	3.7	3.7	5.1				

\*1) GE 4-pole standard motor

\*2) Drive output capacity (kVA) at 230V/460V

\*3) Output voltage cannot exceed the power supply voltage.

\*4) Tested under standard conditions with 85% nominal motor load.

\*5) Obtained with a dc reactor.

\*6) Average braking torque with AVR control OFF (varies with motor efficiency.)

\*7) Average braking torque using external braking resistor (optional)

No braking resistor is available for 1/8 hp, 1/4 hp.

\*8) Voltage unbalance [%] = (Max voltage [V] - Min voltage [V]) / 3-phase average voltage [V] x 67 (IEC61800-3 (5.2.3)) If this value is 2 to 3%, use ac reactor (option).

\*9) Calculated under GE Fuji specified conditions.

\*10) Indicates product revision.

## 2) IP20 type 1-phase 230V series

Item		Specifications						
Input power source		1-phase 230V class						
Type 6KXC121__X9** *9		F12	F25	F50	001	002	003	
Nominal applied motor *1	[hp]	1/8	1/4	1/2	1	2	3	
	[kW]	0.1	0.2	0.4	0.75	1.5	2.2	
Output ratings	Rated capacity *2 [kVA]	0.31	0.59	1.1	1.9	3.1	4.3	
	Rated voltage *3 [V]	3-phase, 200V/50 Hz, 200, 220, 230V/60 Hz						
	Rated current [A]	High carrier (4-15 kHz)	0.7	1.4	2.5	4.2	7.0	10.0
		Low carrier (-3 kHz)	0.8	1.5	3.0	5.0	8.0	11.0
	Overload capability		150% of rated current for 1 min, 200% of rated current for 0.5 s					
	Rated frequency		50, 60 Hz					
Input ratings	Phase, voltage, frequency		1-phase, 200 to 240V, 50/60 Hz					
	Voltage/frequency variations		Voltage: +10 to -10% Frequency: +5 to -5%					
	Momentary voltage dip capability *4		When the input voltage is 165V or more, the drive continues operation. If it drops below 165V, the drive operates for 15 ms.					
	Rated current *8 [A]	(with DCR)	1.1	2.0	3.5	6.4	11.6	17.5
		(without DCR)	1.8	3.3	5.4	9.7	16.4	24.8
Required power supply Capacity *5 [kVA]		0.3	0.5	0.8	1.3	2.4	3.6	
Braking	Torque *6 [%]	150		100		50	30	
	Torque *7 [%]	-		150				
	DC injection braking		Starting frequency: 0.0 to 60.0 Hz, braking time: 0.0 to 30.0 s, braking current: 0 to 100% of rated current					
Conformity to safety standards		UL508C, C22.2No.14, EN50178:1997						
Enclosure (IEC60529)		IP20						
Cooling method		Natural cooling			Fan cooling			
Weight [lbs]		1.3	1.3	1.3	1.8	3.7	5.1	

\*1) GE 4-pole standard motor

\*2) Drive output capacity (kVA) at 230V

\*3) Output voltage cannot exceed the power supply voltage.

\*4) Tested under standard conditions with 85% nominal motor load.

\*5) Obtained with a dc reactor .

\*6) Average braking torque with AVR control OFF (varies with motor efficiency.)

\*7) Average braking torque using external braking resistor (optional)

No braking resistor is available for 1/8 hp, 1/4 hp.

\*8) Calculated under GE Fuji specified conditions.

\*9) Indicates product revision.



### 3) IP20 type 1-phase 115V series

Item		Specifications			
Input power source		1-phase 115V class			
Type 6KXC111__X9**		F12	F25	F50	001
Nominal applied motor *1	[hp]	1/8	1/4	1/2	1
	[kW]	0.1	0.2	0.4	0.75
Output ratings	Rated capacity *2 [kVA]	0.27	0.55	0.99	1.6
	Rated voltage *3 [V]	3-phase, 200V/50 Hz, 200, 220, 230V/60 Hz			
	Rated current [A]	0.7	1.4	2.5	4.2
	Overload capability	150% of rated current for 1 min, 200% of rated current for 0.5 s			
	Rated frequency	50, 60 Hz			
Input ratings	Phase, voltage, frequency		1-phase, 100 to 120V, 50/60 Hz		
	Voltage/frequency variations		Voltage: +10 to -10% Frequency: +5 to -5%		
	Momentary voltage dip capability *4		As long as input voltage is 85V or more, the drive continues operation. If it drops below 85V, the drive operates for 15 ms.		
	Rated current (with DCR)	2.2	3.8	6.4	12.0
	*8 [A] (without DCR)	3.6	5.9	9.5	16.1
Required power supply Capacity *5 [kVA]		0.3	0.4	0.7	1.3
Braking	Torque *6 [%]	150		100	
	Torque *7 [%]	-		150	
	DC injection braking		Starting frequency: 0.0 to 60.0 Hz, braking time: 0.0 to 30.0 s, braking current: 5 to 100% of rated current		
Conformity to safety standards		UL508C, C22.2 No.14			
Enclosure (IEC60529)		IP20			
Cooling method		Natural cooling			
Weight [lbs]		1.3	1.3	1.5	2.6

\*1) GE 4-pole standard motor

\*2) Drive output capacity (kVA) at 230V

\*3) Output voltage cannot exceed the power supply voltage.

\*4) Tested under standard conditions with 85% nominal motor load.

\*5) Obtained with a dc reactor.

\*6) Average braking torque with AVR control OFF (varies with motor efficiency.)

\*7) Average braking torque using external braking resistor (optional)

No braking resistor is available for 1/8 hp, 1/4 hp.

\*8) Calculated under GE Fuji specified conditions.

\*9) Indicates product revision.

#### 4) IP20 with built-in EMC filter, 3-phase 230V/460V series

Item		Specifications															
Input power source		3-phase 230V class						3-phase 460V class									
Type	** *10	F12	F25	F50	001	002	003	005	F50	001	002	003	005				
6KXC123	E9 * *: 230V class																
6KXC143	E9 * *: 460V class																
Nominal motor *1	[hp]	1/8	1/4	1/2	1	2	3	5	1/2	1	2	3	5				
	[kW]	0.1	0.2	0.4	0.75	1.5	2.2	3.7	0.4	0.75	1.5	2.2	3.7				
Output ratings	Rated capacity *2 [kVA]	0.31	0.59	1.1	1.9	3.1	4.3	6.7	1.1	1.9	2.9	4.3	7.1				
	Rated voltage *3 [V]	3-phase 200V/50 Hz, 200, 220, 230V/60 Hz						3-phase 380, 400, 415V/50 Hz, 380, 400, 440, 460V/60 Hz									
	Rated current [A]	High carrier (4-15 kHz)	0.7	1.4	2.5	4.2	7.0	10.0	16.5	1.5	2.5	3.7	5.5	9.0			
		Low carrier (-3 kHz)	0.8	1.5	3.0	5.0	8.0	11.0	17.0								
	Overload capability		150% of rated current for 1 min, 200% of rated current for 0.5 s														
Rated frequency		50, 60 Hz															
Input ratings	Phase, voltage, frequency	3-phase, 200 to 240V, 50/60 Hz						3-phase, 380 to 480V, 50/60 Hz									
	Voltage/frequency variations		Voltage: +10 to -15% (voltage unbalance *8: 2% or less) Frequency: +5 to -5%														
	Momentary voltage dip capability *4		As long as input voltage is 165V or more, the drive continues operation. If it drops below 165V, the drive operates for 15 ms.						As long as input voltage is 300V or more, the drive continues operation. If it drops below 300V, the drive operates for 15 ms.								
	Rated current *9 [A]	(with DCR)	0.57	0.93	1.6	3.0	5.7	8.3	14.0	0.85	1.6	3.0	4.4	7.3			
		(without DCR)	1.1	1.8	3.1	5.3	9.5	13.2	22.2	1.7	3.1	5.9	8.2	13.0			
Required power supply Capacity *5 [kVA]		0.3	0.4	0.6	1.1	2.0	3.0	4.9	0.6	1.1	2.0	2.9	4.9				
Braking	Torque *6 [%]	150		100		50		30		100		50		30			
	Torque *7 [%]	-		150						150							
	DC injection braking		Starting frequency: 0.0 to 60.0 Hz, braking time: 0.0 to 30.0 s, braking level: 0 to 100% of rated current														
Conformity to safety standards		UL508C, C22.2No.14, EN50178:1997															
Conformity to EMC standard *5		_ Conductive/Radiated disturbance Class 1A (EN55011:1998/A1:1999) Immunity _ Industrial environment (second environment) (EN61800-3:1996/A11:2000)															
Enclosure (IEC60529)		IP20															
Cooling method		Natural cooling				Fan cooling				Natural cooling				Fan cooling			
Weight [lbs]		1.5	1.5	1.5	1.8	5.3	5.3	6.4	3.3	3.5	5.5	5.5	6.6				

\*1) GE 4-pole standard motor

\*2) Drive output capacity (kVA) at 230V/460V

\*3) Output voltage cannot exceed the power supply voltage.

\*4) Tested under standard conditions with 85% nominal motor load.

\*5) Obtained with a dc reactor.

\*6) Average braking torque with AVR control OFF (varies with motor efficiency.)

\*7) Average braking torque using external braking resistor (optional) No braking resistor is available for 1/8 hp, 1/4 hp.

\*8) Voltage unbalance [%] = (Max voltage [V] - Min voltage [V]) / 3-phase average voltage [V] x 67 (IEC61800-3 (5.2.3)) If this value is 2 to 3%, use ac reactor (option).

\*9) Calculated under GE Fuji specified conditions.

\*10) Indicates product revision.

### 5) IP20 with EMC filter built-in type 1-phase 230V series

Item		Specifications						
Input power source		1-phase 230V class						
Type 6KXC12__E9** *9		F12	F25	F50	001	002	003	
Nominal applied motor *1	[hp]	1/8	1/4	1/2	1	2	3	
	[kW]	0.1	0.2	0.4	0.75	1.5	2.2	
Output ratings	Rated capacity *2 [kVA]	0.31	0.59	1.1	1.9	3.1	4.3	
	Rated voltage *3 [V]	3-phase, 200V/50 Hz, 200, 220, 230V/60 Hz						
	Rated current [A]	High carrier (4-15 kHz)	0.7	1.4	2.5	4.2	7.0	10.0
		Low carrier (-3 kHz)	0.8	1.5	3.0	5.0	8.0	11.0
	Overload capability		150% of rated current for 1 min, 200% of rated current for 0.5 s					
	Rated frequency		50, 60 Hz					
Input ratings	Phase, voltage, frequency		1-phase, 200 to 240V, 50/60 Hz					
	Voltage/frequency variations		Voltage: +10 to -10% Frequency: +5 to -5%					
	Momentary voltage dip capability *4		As long as input voltage is 165V or more, the drive continues operation. If it drops below 165V, the drive operates for 15 ms.					
	Rated current *8 [A]	(with DCR)	1.1	2.0	3.5	6.4	11.6	17.5
		(without DCR)	1.8	3.3	5.4	9.7	16.4	24.8
Required power supply Capacity *5 [kVA]		0.3	0.5	0.8	1.3	2.4	3.6	
Braking	Torque *6 [%]	150		100		50	30	
	Torque *7 [%]	-		150				
	DC injection braking		Starting frequency: 0.0 to 60.0 Hz, braking time: 0.0 to 30.0 s, braking current: 5 to 100% of rated current					
Conformity to safety standards		UL508C, C22.2No.14, EN50178:1997						
Conformity to EMC standard		__Conductive/Radiated disturbance__ Class 1A (EN55011:1998/A1:1999) __Immunity__ Industrial environment(second environment) (EN61800-3:1996/A11:2000)						
Enclosure (IEC60529)		IP20						
Cooling method		Natural cooling			Fan cooling			
Weight [lbs]		1.5	1.5	1.5	2.6	5.3	6.4	

\*1) GE 4-pole standard motor

\*2) Drive output capacity (kVA) at 230V

\*3) Output voltage cannot exceed the power supply voltage.

\*4) Tested under standard conditions with 85% nominal motor load.

\*5) Obtained with a dc reactor.z

\*6) Average braking torque with AVR control OFF (varies with motor efficiency.)

\*7) Average braking torque using external braking resistor (optional)

No braking resistor is available for 1/8 hp, 1/4 hp.

\*8) Calculated under GE Fuji specified conditions.

\*9) Indicates product revision.

## 8.2 Common Specifications

Item		Explanation	
Output frequency	Setting range	Maximum frequency	25 to 400 Hz
		Base frequency	25 to 400 Hz
		Starting frequency	0.1 to 60.0 Hz
		Carrier frequency	0.75 to 15k Hz (Frequency may drop automatically to protect the drive running at 7kHz or over.)
	Accuracy (Stability)	Analog setting: $\pm 2\%$ of max freq. (at 25°C), temperature drift: $\pm 0.2\%$ of max freq. (at 25 $\pm$ 10°C) Keypad setting: $\pm 0.01\%$ of max freq. (at 25°C), temperature drift: $\pm 0.01\%$ of max freq. (at -10 to +50°C)	
Setting resolution	Analog setting: 1/1000 of max freq. Keypad setting: 0.01 Hz (99.99 Hz or less), 0.1 Hz (100.0 to 400.0Hz) Link setting: Selectable from 2 types 1/20000 of max freq. (ex. 0.003 Hz at 60 Hz, 0.006 Hz at 120 Hz, 0.02 Hz at 400 Hz) 0.01 Hz (fixed)		
Control	Control method	V/f control (Simplified torque-vector control)	
	Voltage/freq. characteristic	200V class	Output voltage between 80 and 240V can be set at base frequency and at maximum. AVR control can be turned ON or OFF. Desired 1 point on non-linear V/f curve: 0 to 240V, 0 to 400Hz can be set.
		100V class	Output voltage between 160 and 500V at base frequency and at maximum output frequency (common spec). AVR control can be turned ON or OFF. Desired 1 point on non-linear V/f curve: 0 to 500V, 0 to 400 Hz can be set.
		400V class	Output voltage between 160 and 500V at base frequency and at maximum output frequency (common spec). AVR control can be turned ON or OFF. Desired 1 point on non-linear V/f curve: 0 to 500V, 0 to 400 Hz can be set.
	Torque boost	Auto torque boost (constant torque load) Manual torque boost (Constant torque load or variable torque load can be selected.)	
	Starting torque	150% or over (Auto torque boost in 5 Hz operation)	
	Start/Stop	Keypad operation: Start and stop with RUN/STOP keys External signal: FWD-stop (REV-stop) [3-wire operation possible], (Digital input) coast-to-stop command, external alarm, alarm reset, etc. Timer operation: Stop after elapse of the time set with the keypad. Link operation: Communication via RS485 (option)	
	Frequency setting	Can be set with UP or DOWN key. Can be set with built-in potentiometer. Can be set with variable resistor (External potentiometer: 1 to 5k $\Omega$ /2W) 0 to +10 Vdc (+5 Vdc) (+5V: by changing the setting of analog input gain (200%)) +1 to +5 Vdc (adjustable by bias or analog input gain) 4 to 20mA dc	
	(Analog input)		
	(Multistep freq. setting) (Link operation)	Multistep speed operation: Selectable from 8 steps by 3-bit external signal Can be set with communication via RS485 (option)	
	(Freq. setting change)	Two types of freq. settings can be switched with an external signal (digital input).	
	(Freq. aux. setting)	Built-in potentiometer, terminal 12 input, or terminal C1 input can be selected to add the frequency.	
	(Inverse operation)	Possible to switch (0 to +10 Vdc)/(0 to 100%) to (+10 to 0 Vdc)/(0 to 100%) with an external signal. Possible to switch (4 to 20mA dc)/(0 to 100%) to (20 to 4mA dc)/(0 to 100%) with an external signal.	
Acceleration/ deceleration time	Changeable with the range from 0.00 to 3600s. (Two times each for acceleration and deceleration can be set internally.) Acceleration and deceleration pattern can be selected from 4 kinds: Linear, S-curve (weak), S-curve (strong), Non-linear (Max. constant output).		
DC injection braking	Starting frequency: 0.0 to 60.0 Hz, Braking time: 0.0 to 30.0s, Braking level: 5 to 100% of rated current		

Item	Explanation	
Control	Frequency limiter	High and low limiters [Hz] can be set. (Setting range: 0 to 400 Hz)
	Bias frequency	Biases of set freq. and PID command can be set between 0 and $\pm 100\%$ .
	Gain for frequency setting	Analog input gain can be set within the range from 0 to 200%. At voltage input, proportional frequency can be set to 10.5V and 21mA by adjusting gain.
	Jump frequency control	Three operation points and their jump hysteresis width (0 to 30Hz) can be set.
	Jogging operation	Operation by the RUN key or digital input signal (FWD $\square$ REV) (Frequency setting and ACC/DEC time common setting exclusive for jogging)
	Auto-restart after momentary power failure	Restarts the drive without stopping the motor after instantaneous power failure.
	Slip compensation	Compensates for decrease in speed according to the load during constant speed operation.
	Current limit (By hardware)	Limits the current to prevent overcurrent trip caused by rapid load change or instantaneous power failure when current limitation by the software is impossible. (This function can be canceled.)
	(By software)	Automatically reduces the frequency to make output current under the preset value. (Current limit condition can be selected from between "constant speed operation only" and "acceleration and constant speed operation".)
	PID control	Process PID control can be made. Process command: Keypad, built-in potentiometer, analog input (12, C1), RS485 communication Feedback signal: Analog input (12, C1)
	Automatic deceleration	Makes the deceleration time 3 times longer to avoid OV trip when dc link circuit voltage exceeds the overvoltage limit.
	Auto energy saving operation	Controls output voltage to minimize motor loss during constant speed operation. (Torque boost during acceleration can be selected from manual variable torque, manual constant torque, and auto torque.)
Overload prevention control	Decreases the output frequency automatically to prevent tripping before the inverter's overload preventive function is activated by ambient temperature rise, frequent use, or large motor load.	
Cooling fan stop operation	Detects drive inside temperature and stops cooling fan when the temperature is low.	
Indication	Running/stopping	Speed monitor, output current [A], output voltage [V], input power [kW], PID reference, PID feedback value Select the speed monitor to be displayed from the following: Output frequency (before slip compensation) [Hz], output frequency (after slip compensation) [Hz], set frequency [Hz], motor speed [r/min.], load shaft speed [r/min.], line speed [m/min.], constant rate of feeding time
	Trip mode	[Displays the cause of trip by codes as follows.] OC1 (Overcurrent during acceleration) OC2 (Overcurrent during deceleration) OC3 (Overcurrent during running at constant speed) Lin (Input phase loss) LU (Undervoltage) OPL (Output phase loss) OU1 (Overvoltage during acceleration) OU2 (Overvoltage during deceleration) OU3 (Overvoltage during running at constant speed) OH1 (Overheating at heat sink) OH2 (External thermal relay tripped) OH4 (Motor protection (PTC thermistor)) dbH (Overheating at DB circuit) OL1 (Motor overload) OLU (Drive unit overload) Er1 (Memory error) Er2 (Remote keypad communication error) Er3 (CPU error) Er6 (Operation procedure error) Er8 (RS485 error) ErF (Data save error due to undervoltage)
	Running or trip mode	Trip history: Saves and displays the last 4 trip cause (codes) and their detailed description.

Item		Explanation	
Protection	Overcurrent	Stops the drive by detecting overcurrent caused by overload in the output circuit.	
	Short-circuit	Stops the drive by detecting overcurrent caused by short-circuit in the output circuit.	
	Ground fault	Stops the drive by detecting overcurrent caused by ground fault in the output circuit. (Detected when the drive is started.)	
	Overvoltage	Stops the drive by detecting overvoltage (100V/200V series: 400 Vdc, 400V series: 800V) in dc link circuit.	
	Incoming surge	Protects the drive from surge voltage entering between main circuit power cable and earth cable.	
	Undervoltage	Stops the drive by detecting voltage drop (100V/200V series: 200V DC, 400V series: 400V) in dc link circuit.	
	Input phase loss	Stops the drive against input phase loss (by simply detecting the ripple voltage at a capacitor).	
	Output phase loss	Stops the drive by detecting output cable's phase loss at the start of operation or during operation.	
	Overheating		Stop the drive by detecting drive heat sink temperature caused by a failure or overload of the cooling fan.
			Stops the drive and built-in braking transistor if "discharging capability" or "allowable loss" set for the braking resistor is exceeded more frequency than the set number of times.
	Overload	Stops the drive by calculating the IGBT internal temperature from the output current and drive heat sink temperature.	
	Motor protection	Electric thermal	Stops the drive to protect the motor when the set output current is exceeded. (Thermal time constant can be adjusted 0.5 to 75.0min.)
		PTC thermistor	A PTC thermistor stops the drive to protect the motor.
		Overload early warning	Warning signal can be output based on the preset level before stopping the drive.
Stall	Lowens output frequency to prevent overcurrent trip when output current exceeds the limit value during acceleration, deceleration, or constant speed operation.		
Retry function	When the motor is tripped and stopped, this function automatically reset the tripping state and restarts operation. (Waiting time before resetting and the number of retry times can be set.)		
Environment	Installation location	Shall be free from corrosive gases, flammable gases, oil mist, dust, and direct sunlight. (Pollution degree 2) Indoor use only	
	Ambient temperature	Open air : -10 to +50°C (IP20), -10 to +40°C (NEMA1)	
	Ambient humidity	5 to 95%RH (no condensation)	
	Altitude	1000m or lower	
	Vibration	3mm : 2 to less than 9 Hz 9.8m/s <sup>2</sup> : 9 to less than 20 Hz 2m/s <sup>2</sup> : 20 to less than 55 Hz 1m/s <sup>2</sup> : 55 to less than 200 Hz	
	Storage ambient temp.	-25 to +65°C	
	Storage ambient humidity	5 to 95%RH (no condensation)	

## 8.3 Terminal Specifications

### 8.3.1 Terminal Functions

For details about the main and control circuit terminals, refer to Chapter 2, Subsection 2.3.4 and Subsection 2.3.6 (Table 2.4), respectively.

### 8.3.2 Connection Diagram for Operation by External Signal Inputs

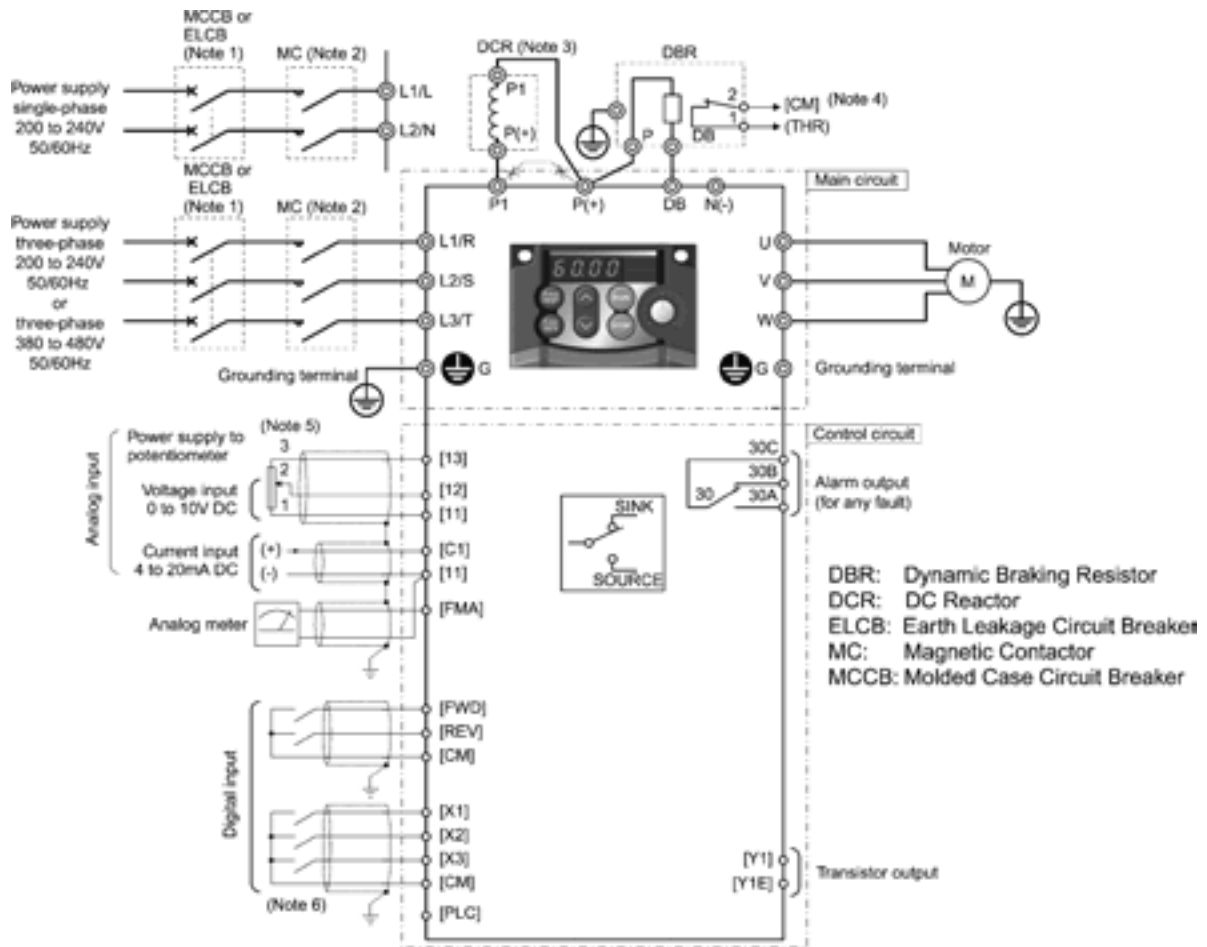

Note 1: Install a recommended molded case circuit breaker or a ground fault circuit interrupter (GFCI) in the primary circuit of the drive to protect wiring. At this time, ensure that the circuit breaker rating is equivalent to or lower than the recommended rating.

Note 2: If magnetic contactors or solenoids are near the drive, connect a surge suppressor across their coils.

Note 3: When connecting a dc reactor (option), remove the jumper bar from across terminals [P1] and [P+].

Note 4: The (THR) function can be used by assigning code “9” (Alarm from external equipment) to any of terminals [X1] to [X3], [FWD] or [REV] (function code; E01 to E03, E98, or E99). For details, refer to Chapter 9.

Note 5: Frequency can be set by connecting a frequency command device (external potentiometer) between the terminals [11] and [13] instead of inputting voltage signal (0 to +10 Vdc or 0 to +5 Vdc) between the terminals [12] and [11].

Note 6: Use shielded or twisted wires for control circuit wiring. When using shielded wires, connect the shields to G. To prevent malfunction due to noise, keep the control circuit wiring as far away from the main circuit wiring as possible (10 cm or farther recommended), and never install them in the same wire duct. When control circuit wiring must cross the main power circuit wiring, position the cables at right angles.

## 8.4 External Dimensions

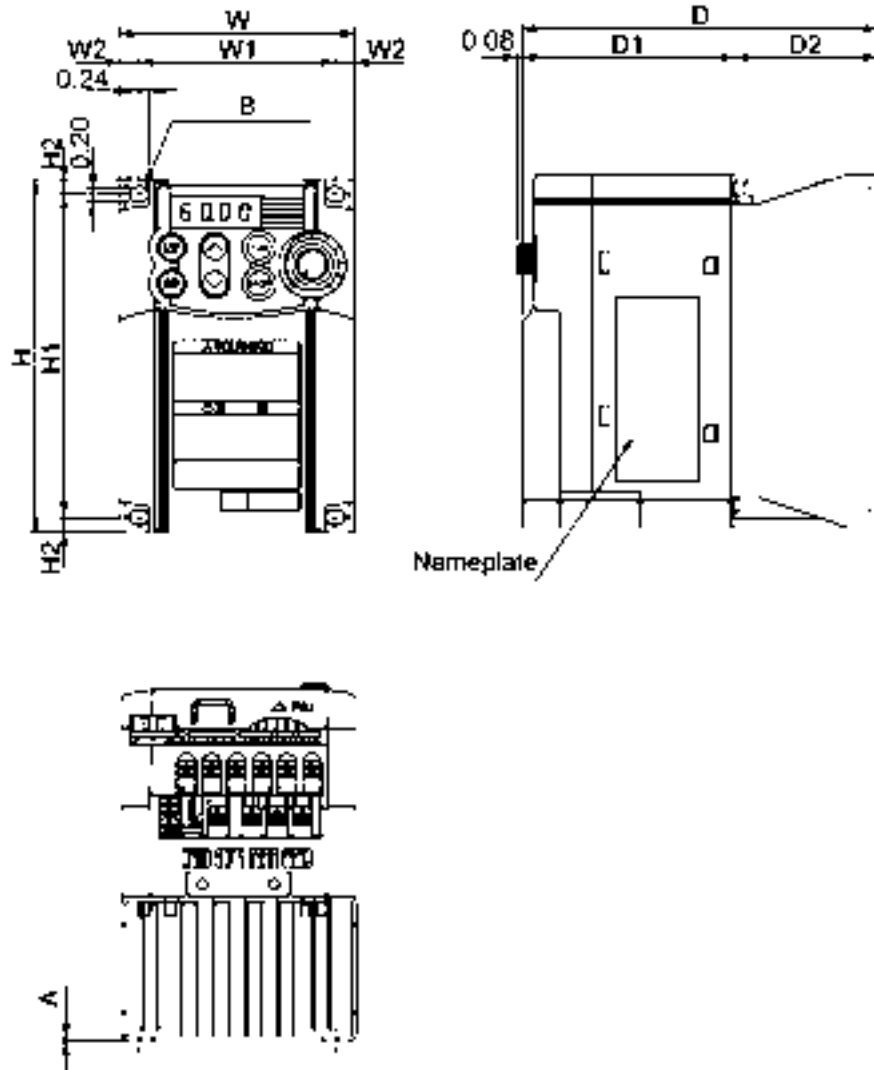

(See dimensions table on next page)



Model No.	Dimensions inches (mm)										
	W	W1	W2	H	H1	H2	D	D1	D2	A	B
<b>3-phase 230V</b>											
6KXC123F12X9**	3.15 (80)	2.64 (67)	0.26 (6.5)	4.72 (120)	4.33 (110)	0.20 (5)	3.15 (80)	2.76 (70)	0.39 (10)	0.06 (1.5)	4-0.2 x 0.24 (4-5x6)
6KXC123F25X9**	3.15 (80)	2.64 (67)	0.26 (6.5)	4.72 (120)	4.33 (110)	0.20 (5)	3.15 (80)	2.76 (70)	0.39 (10)	0.06 (1.5)	4-0.2 x 0.24 (4-5x6)
6KXC123F50X9**	3.15 (80)	2.64 (67)	0.26 (6.5)	4.72 (120)	4.33 (110)	0.20 (5)	3.74 (95)	2.76 (70)	0.98 (25)	0.06 (1.5)	4-0.2 x 0.24 (4-5x6)
6KXC123001X9**	3.15 (80)	2.64 (67)	0.26 (6.5)	4.72 (120)	4.33 (110)	0.20 (5)	4.72 (120)	2.76 (70)	1.97 (50)	0.06 (1.5)	4-0.2 x 0.24 (4-5x6)
<b>1-phase 230V</b>											
6KXC121F12X9**	3.15 (80)	2.64 (67)	0.26 (6.5)	4.72 (120)	4.33 (110)	0.20 (5)	3.15 (80)	2.76 (70)	0.39 (10)	0.06 (1.5)	4-0.2 x 0.24 (4-5x6)
6KXC121F25X9**	3.15 (80)	2.64 (67)	0.26 (6.5)	4.72 (120)	4.33 (110)	0.20 (5)	3.15 (80)	2.76 (70)	0.39 (10)	0.06 (1.5)	4-0.2 x 0.24 (4-5x6)
6KXC121F50X9**	3.15 (80)	2.64 (67)	0.26 (6.5)	4.72 (120)	4.33 (110)	0.20 (5)	3.74 (95)	2.76 (70)	0.98 (25)	0.06 (1.5)	4-0.2 x 0.24 (4-5x6)
6KXC121001X9**	3.15 (80)	2.64 (67)	0.26 (6.5)	4.72 (120)	4.33 (110)	0.20 (5)	5.51 (140)	2.76 (70)	1.97 (50)	0.06 (1.5)	4-0.2 x 0.24 (4-5x6)
<b>1-phase 115V</b>											
6KXC111F12X9**	3.15 (80)	2.64 (67)	0.26 (6.5)	4.72 (120)	4.33 (110)	0.20 (5)	3.94 (100)	3.54 (90)	0.39 (10)	0.06 (1.5)	4-0.2 x 0.24 (4-5x6)
6KXC111F25X9**	3.15 (80)	2.64 (67)	0.26 (6.5)	4.72 (120)	4.33 (110)	0.20 (5)	3.94 (100)	3.54 (90)	0.39 (10)	0.06 (1.5)	4-0.2 x 0.24 (4-5x6)
6KXC111F50X9**	3.15 (80)	2.64 (67)	0.26 (6.5)	4.72 (120)	4.33 (110)	0.20 (5)	4.53 (115)	3.54 (90)	0.98 (25)	0.06 (1.5)	4-0.2 x 0.24 (4-5x6)
<b>EMC Filters Built-in Type</b>											
<b>3-phase 230V</b>											
6KXC123F12E9**	3.15 (80)	2.64 (67)	0.26 (6.5)	6.67 (170)	4.33 (110)	0.20 (5)	3.94 (100)	3.54 (90)	0.39 (10)	0.06 (1.5)	4-0.2 x 0.24 (4-5x6)
6KXC123F25E9**	3.15 (80)	2.64 (67)	0.26 (6.5)	6.67 (170)	4.33 (110)	0.20 (5)	3.94 (100)	3.54 (90)	0.39 (10)	0.06 (1.5)	4-0.2 x 0.24 (4-5x6)
6KXC123F50E9**	3.15 (80)	2.64 (67)	0.26 (6.5)	6.67 (170)	4.33 (110)	0.20 (5)	4.53 (115)	3.54 (90)	0.98 (25)	0.06 (1.5)	4-0.2 x 0.24 (4-5x6)
6KXC123001E9**	3.15 (80)	2.64 (67)	0.26 (6.5)	6.67 (170)	4.33 (110)	0.20 (5)	5.51 (140)	3.54 (90)	1.97 (50)	0.06 (1.5)	4-0.2 x 0.24 (4-5x6)
<b>1-phase 230V</b>											
6KXC121F12E9**	3.15 (80)	2.64 (67)	0.26 (6.5)	6.67 (170)	4.33 (110)	0.20 (5)	3.94 (100)	3.54 (90)	0.39 (10)	0.06 (1.5)	4-0.2 x 0.24 (4-5x6)
6KXC121F25E9**	3.15 (80)	2.64 (67)	0.26 (6.5)	6.67 (170)	4.33 (110)	0.20 (5)	3.94 (100)	3.54 (90)	0.39 (10)	0.06 (1.5)	4-0.2 x 0.24 (4-5x6)
6KXC121F50E9**	3.15 (80)	2.64 (67)	0.26 (6.5)	6.67 (170)	4.33 (110)	0.20 (5)	4.53 (115)	3.54 (90)	0.98 (25)	0.06 (1.5)	4-0.2 x 0.24 (4-5x6)

\*\* Indicates product revision.

NOTE: EMC Filter Built-in type H size includes EMC flange for shield cable.

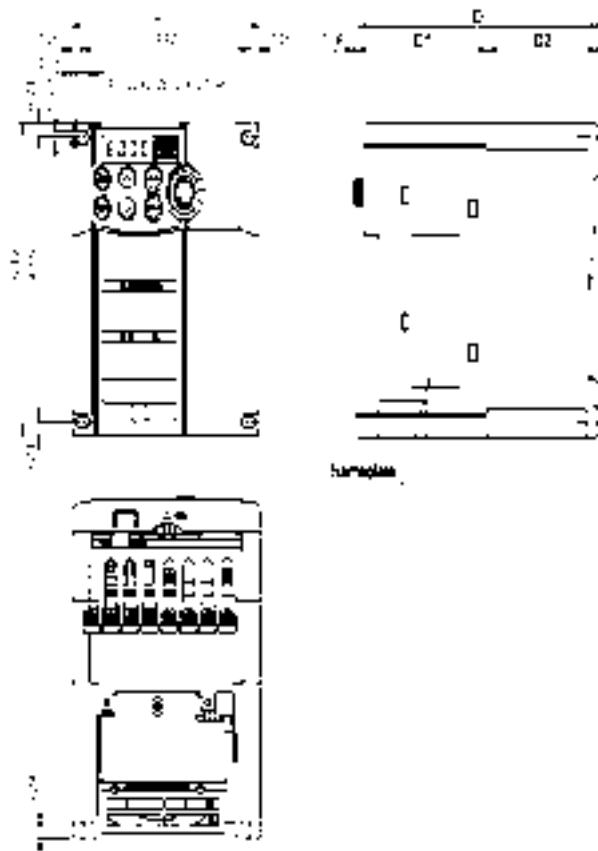

Model No.	Dimensions inches (mm)		
	D	D1	D2
<b>3-phase 230V</b>			
6KXC123002X9 **	5.47 (139)	2.95 (75)	2.52 (64)
6KXC123003X9 **	5.47 (139)	2.95 (75)	2.52 (64)
<b>3-phase 460V</b>			
6KXC143F50X9 **	4.53 (115)	2.95 (75)	1.57 (40)
6KXC143001X9 **	5.47 (139)	2.95 (75)	2.52 (64)
6KXC143002X9 **	5.47 (139)	2.95 (75)	2.52 (64)
6KXC143003X9 **	5.47 (139)	2.95 (75)	2.52 (64)
<b>1-phase 230V</b>			
6KXC121002X9 **	5.87 (149)	3.35 (85)	2.52 (64)
<b>1-phase 115V</b>			
6KXC111001X9 **	5.47 (139)	3.90 (99)	1.57 (40)
<b>EMC Filters Built-in Type</b>			
<b>3-phase 460V</b>			
6KXC143F50E9 **	6.22 (158)	4.65 (118)	1.57 (40)
6KXC143001E9 **	7.17 (182)	4.65 (118)	2.52 (64)
<b>1-phase 230V</b>			
6KXC121001E9**	5.47 (139)	3.90 (99)	1.57 (40)
** Indicates Products Revision			

If “EMC filter Built-in Type” is supplied, the total height is 7.05", which includes the EMC flange for shielded cable connection.

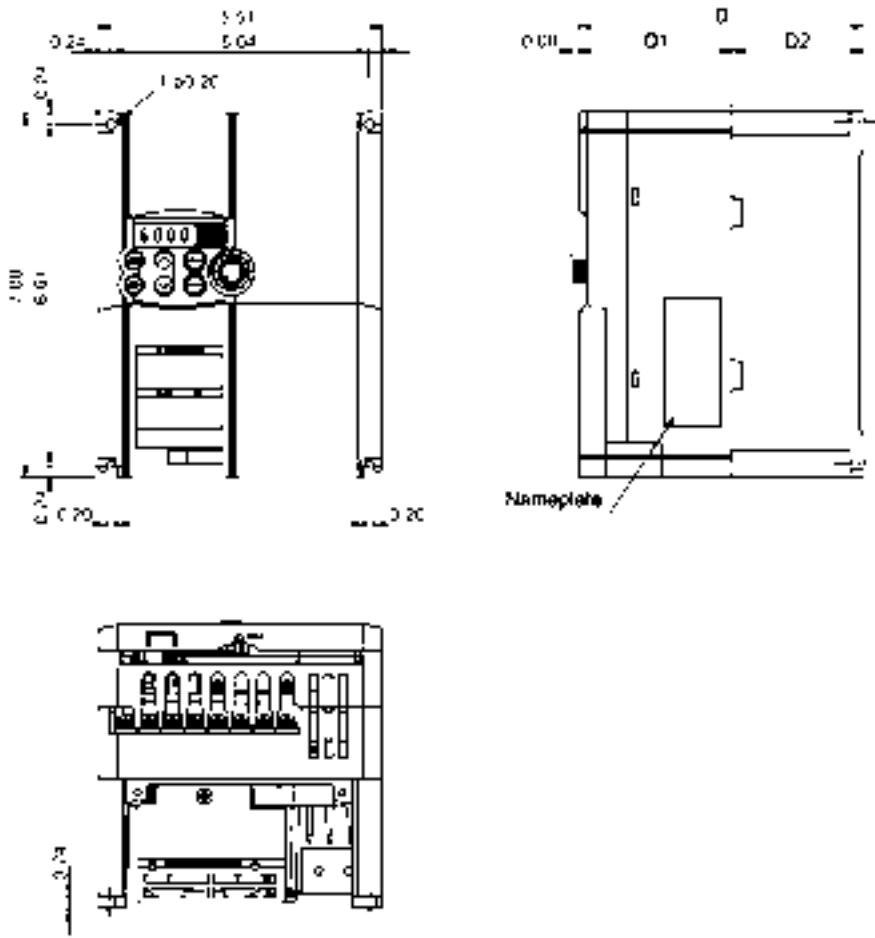



Model No.	Dimensions inches (mm)		
	D	D1	D2
<b>3-phase 230V</b>			
6KXC123005X9 **	5.47 (139)	2.95 (75)	2.52 (64)
<b>3-phase 460V</b>			
6KXC143005X9 **	5.47 (139)	2.95 (75)	2.52 (64)
<b>1-phase 230V</b>			
6KXC121003X9 **	5.47 (139)	2.95 (75)	2.52 (64)
<b>EMC Filters Built-in Type</b>			
<b>3-phase 230V</b>			
6KXC123002E9 **	7.17 (182)	4.65 (118)	2.52 (64)
6KXC123003E9 **	7.17 (182)	4.65 (118)	2.52 (64)
6KXC123005E9 **	7.17 (182)	4.65 (118)	2.52 (64)
<b>3-phase 460V</b>			
6KXC143002E9 **	7.17 (182)	4.65 (118)	2.52 (64)
6KXC143003E9 **	7.17 (182)	4.65 (118)	2.52 (64)
6KXC143005E9 **	7.17 (182)	4.65 (118)	2.52 (64)
<b>1-phase 230V</b>			
6KXC121002E9 **	7.17 (182)	4.65 (118)	2.52 (64)
6KXC121003E9 **	7.17 (182)	4.65 (118)	2.52 (64)
** Indicates product revision			

If "EMC filter Built-in Type" is supplied, the total height is 9.65", which includes the EMC flange for shielded cable connection.

## 8.5 Protective Functions

Name		Description	LED monitor displays	Alarm output [30A, B, C]	
Overcurrent protection		<ul style="list-style-type: none"> <li>- Stops the motor to protect the drive from an overcurrent resulting from overload.</li> <li>- Stops the motor to protect drive from an overcurrent due to a short-circuit in the output circuit.</li> <li>- Stops the motor to protect drive from an overcurrent due to a ground fault in the output circuit.</li> </ul>	During acceleration	0C1	Yes
			During deceleration	0C2	
			During running at constant speed	0C3	
Overvoltage protection		The drive stops the motor by detecting an overvoltage (400 Vdc for 230 V series, 800 Vdc for 460 V series) in the intermediate dc circuit. This protection is not assured if excess ac line voltage is accidentally applied.	During acceleration	0U1	Yes
			During deceleration	0U2	
			During running at constant speed (Stopped)	0U3	
Undervoltage protection		Stops the motor when the intermediate dc circuit voltage drops below the undervoltage level (200 Vdc for 230 V series, 400 Vdc for 460 V series). However, if data "4" or "5" are selected for F14, there is no alarm output even if the intermediate dc circuit voltage drops.	LU	Yes*	
Input phase loss protection		Detects input phase loss, stopping the motor.	L <sub>in</sub>	Yes	
Output phase loss protection		Detects output phase loss during starting and running, stopping the drive.	0PL	Yes	
Overheat protection		<ul style="list-style-type: none"> <li>- Stops the motor by detecting excess heat sink temperature in case of cooling fan failure or overload.</li> <li>- When the built-in or external braking resistor overheats, the drive stops running.</li> </ul> * It is necessary to set the function code corresponding to the resistor used (built-in or external).	0H1	Yes	
			dbH	Yes	
Overload protection		Stops the motor if the IGBT internal temperature calculated from the output current and cooling fan temperature detection is over the preset value.	0LU	Yes	
Motor protection	Electronic thermal overload relay	In the following cases, the drive stops running the motor to protect the motor in accordance with the electronic thermal function setting. <ul style="list-style-type: none"> <li>- Protects general-purpose motors over the entire frequency range.</li> <li>- Protects drive motors over the entire frequency range.</li> </ul> * The operation level and thermal time constant can be set.	0L1	Yes	
	PTC thermistor	<ul style="list-style-type: none"> <li>- A PTC thermistor input stops the motor for motor protection. A PTC thermistor is connected between terminals [C1] and [11], and a 1-kΩ external resistor is connected between terminals [13] and [C1].</li> </ul>	0H4	Yes	

\* This alarm may not be triggered, depending on the function code data.

Name		Description	LED monitor displays	Alarm output [30A, B, C]
Motor protection	Overload early warning	Outputs a preliminary alarm at a preset level before the motor is stopped by the electronic thermal function, for the purpose of protecting the motor.	-	-
	Stall prevention	Operates when the current limit is active. - Current limit: Operates if the current limit set in the hardware is exceeded by the drive's output current, avoiding tripping of the drive (during constant speed operation or during acceleration).	-	-
External alarm input		- Stops the motor with an alarm through the digital input signal (THR).	0H2	Yes
Alarm relay output (for any fault)		- The drive outputs a relay contact signal when the drive issues an alarm, and stops the motor. Alarm Reset: the alarm stop state is reset by pressing the  key, or by the digital input signal (RST). Saving the alarm history and detailed data: information for the previous 4 alarms can be saved and displayed.	-	Yes
Memory error		The drive checks memory data after power-on and when the data is written. If a memory error is detected, the drive stops.	Er1	Yes
Remote keypad communications error		The drive stops on detecting any communication error between the drive and the remote keypad (option) during operation from the remote keypad. * If the drive detects a communication error when the remote keypad is connected with the power on, or when the power is turned on with the remote keypad connected, it displays Er2 without alarm relay output.	Er2	Yes*
CPU error		If the drive detects a CPU error caused by noise or some other factor, the drive stops.	Er3	Yes
Operation Protection	STOP key priority	Pressing  key on the keypad forces the motor to decelerate and stop even if the drive is running by any run commands given via the terminals or communications (link operation). After the motor stops, the drive issues an alarm "Er6".	Er6	Yes
	Start check function	Any run operations are prohibited, and the drive displays "Er6" on the LED display if any run command is given when: - Powering up - Releasing an alarm (  key turned ON) - Link command (LE) has switched drive operations	Er6	Yes
RS485 communication error		On detecting an RS485 communication error, the drive displays the alarm code.	Er8	Yes
Data save error during undervoltage		If the data could not be saved during activation of the undervoltage protection function, the drive displays the alarm code.	ErF	Yes

\* This alarm may not be triggered, depending upon the function code data.

"---": Not applicable

# ***Notes***

## 9. List of Peripheral Equipment and Options

The table below lists the main peripheral equipment and options that may be connected to the AF-300 Mini. Use them in accordance with your system requirements.

REFERENCE: For details, refer to the AF-300 Mini User's Manual, Chapter 6 "Selecting Peripheral Equipment."

	Name of peripheral equipment	Function and application																																																																																														
Main peripheral equipment	Molded case circuit breaker (MCCB)	<p>Molded Case Circuit Breakers (MCCBs) are designed to protect the power circuits between the power distribution panel and the drive's main terminals (L1/R, L2/S and L3/T for 3-phase, or L1/L and L2/N for 1-phase power source) from overload or short-circuit. This in turn prevents secondary damage caused by the drive malfunctioning. Use the MCCBs with recommended rated currents listed in the table below.</p> <table border="1" data-bbox="513 579 1289 1881"> <thead> <tr> <th rowspan="2">Applicable Motor Rating (hp)</th> <th rowspan="2">Drive Hp</th> <th colspan="2">Recommended rated current (A) of MCCB</th> </tr> <tr> <th>w/DC Reactor</th> <th>w/o DC Reactor</th> </tr> </thead> <tbody> <tr> <td colspan="4"><b>3-phase 230 V</b></td> </tr> <tr> <td>1/8</td> <td>1/8</td> <td rowspan="3">5</td> <td rowspan="3">5</td> </tr> <tr> <td>1/4</td> <td>1/4</td> </tr> <tr> <td>1/2</td> <td>1/2</td> </tr> <tr> <td>1</td> <td>1</td> <td rowspan="3">10</td> <td>10</td> </tr> <tr> <td>2</td> <td>2</td> <td rowspan="2">15</td> </tr> <tr> <td>3</td> <td>3</td> </tr> <tr> <td>5</td> <td>5</td> <td>20</td> <td>30</td> </tr> <tr> <td colspan="4"><b>3-phase 460 V</b></td> </tr> <tr> <td>1/2</td> <td>1/2</td> <td rowspan="3">5</td> <td rowspan="3">5</td> </tr> <tr> <td>1</td> <td>1</td> </tr> <tr> <td>2</td> <td>2</td> </tr> <tr> <td>3</td> <td>3</td> <td rowspan="2">10</td> <td>15</td> </tr> <tr> <td>5</td> <td>5</td> <td>20</td> </tr> <tr> <td colspan="4"><b>1-phase 230 V</b></td> </tr> <tr> <td>1/8</td> <td>1/8</td> <td rowspan="3">5</td> <td rowspan="3">5</td> </tr> <tr> <td>1/4</td> <td>1/4</td> </tr> <tr> <td>1/2</td> <td>1/2</td> </tr> <tr> <td>1</td> <td>1</td> <td>10</td> <td>15</td> </tr> <tr> <td>2</td> <td>2</td> <td>15</td> <td>20</td> </tr> <tr> <td>3</td> <td>3</td> <td>20</td> <td>20</td> </tr> <tr> <td colspan="4"><b>1-phase 115 V</b></td> </tr> <tr> <td>1/8</td> <td>1/8</td> <td>5</td> <td>5</td> </tr> <tr> <td>1/4</td> <td>1/4</td> <td>5</td> <td>10</td> </tr> <tr> <td>1/2</td> <td>1/2</td> <td>10</td> <td>15</td> </tr> <tr> <td>1</td> <td>1</td> <td>15</td> <td>20</td> </tr> </tbody> </table>	Applicable Motor Rating (hp)	Drive Hp	Recommended rated current (A) of MCCB		w/DC Reactor	w/o DC Reactor	<b>3-phase 230 V</b>				1/8	1/8	5	5	1/4	1/4	1/2	1/2	1	1	10	10	2	2	15	3	3	5	5	20	30	<b>3-phase 460 V</b>				1/2	1/2	5	5	1	1	2	2	3	3	10	15	5	5	20	<b>1-phase 230 V</b>				1/8	1/8	5	5	1/4	1/4	1/2	1/2	1	1	10	15	2	2	15	20	3	3	20	20	<b>1-phase 115 V</b>				1/8	1/8	5	5	1/4	1/4	5	10	1/2	1/2	10	15	1	1	15	20
	Applicable Motor Rating (hp)	Drive Hp			Recommended rated current (A) of MCCB																																																																																											
			w/DC Reactor	w/o DC Reactor																																																																																												
	<b>3-phase 230 V</b>																																																																																															
	1/8	1/8	5	5																																																																																												
	1/4	1/4																																																																																														
	1/2	1/2																																																																																														
	1	1	10	10																																																																																												
	2	2		15																																																																																												
	3	3																																																																																														
	5	5	20	30																																																																																												
	<b>3-phase 460 V</b>																																																																																															
	1/2	1/2	5	5																																																																																												
	1	1																																																																																														
	2	2																																																																																														
	3	3	10	15																																																																																												
	5	5		20																																																																																												
	<b>1-phase 230 V</b>																																																																																															
	1/8	1/8	5	5																																																																																												
	1/4	1/4																																																																																														
	1/2	1/2																																																																																														
	1	1	10	15																																																																																												
	2	2	15	20																																																																																												
	3	3	20	20																																																																																												
	<b>1-phase 115 V</b>																																																																																															
1/8	1/8	5	5																																																																																													
1/4	1/4	5	10																																																																																													
1/2	1/2	10	15																																																																																													
1	1	15	20																																																																																													

	Name of peripheral equipment	Function and application
Main peripheral equipment		<p><b>WARNING</b> When connecting the drive to the power supply, add a recommended molded case circuit breaker in the power supply circuit. Do not use the devices with the rated current out of the recommended range.</p> <p><b>Fire could occur.</b></p>
	Magnetic contactor (MC)	<p>An MC can be used on both the power input and output sides of the drive. On each side, the MC works as described below. When inserted in the output circuit of the drive, an MC can also switch the motor drive power source between the drive output and commercial power lines.</p> <p>■ At the power source side Insert an MC in the power source side of the drive in order to:</p> <ol style="list-style-type: none"> <li>1) Forcibly disconnect the drive from its power source (generally, commercial/factory power lines) with the protection facility built into the drive, or with the terminal signal line.</li> <li>2) Stop drive operation in an emergency when the drive cannot interpret the stop command due to internal/external circuit failures.</li> <li>3) Cut off the drive from the power source when the MCCB inserted in the power source side cannot disconnect it for maintenance or inspection purposes. For this purpose only, it is recommended that you use an MC capable of being turned on/off manually.</li> </ol> <p>Note: When your system requires the motor(s) driven by the drive to be started/stopped with the MC, the frequency of the starting/stopping operation should be no more than once per hour. The more frequent the operation, the shorter the life of the MC and capacitor(s) used in the intermediate DC circuit, due to thermal fatigue caused by the frequent establishment of the current flow. If this is not necessary, start/stop the motor with the terminal commands (FWD), (REV) and/or (HLD), or with the keypad.</p> <p>■ At the output side Prevents externally back-fed current from being applied to the drive power output terminals (U, V, and W) unexpectedly. An MC should be used, for example, if a circuit that switches the motor driving source between the drive output and commercial/factory power lines is connected to the drive.</p> <p>Note: As application of high voltage external current to the drive's secondary (output) circuits may damage the IGBTs, MCs should be used in the power control system circuits to switch the motor drive power source to the commercial/factory power lines after the motor has come to a complete stop. Also ensure that voltage is never mistakenly applied to the drive output terminals due to unexpected timer operation, or similar.</p> <p>■ Driving the motor using commercial power lines MCs can also be used to switch the power source of the motor driven by the drive to a commercial power source.</p>



	Name of option	Function and application
Main option	Braking resistors (Standard model) (DBRs)	A braking resistor converts regenerative energy derived from deceleration of the motor and converts it to heat for dissipation. Use of a braking resistor results in improved deceleration performance of the drive.
	DC reactors (DCRs)	<p>A DCR is mainly used for power supply normalization, and for supplied power factor correction (for reducing harmonic components).</p> <p>1) For power supply normalization</p> <ul style="list-style-type: none"> <li>- Use a DCR when the capacity of a power supply transformer exceeds 500 kVA and is 10 times or more the rated drive capacity. In this case, the percentage-reactance of the power source decreases, and harmonic components and their peak levels increase. These factors may damage rectifiers or capacitors in the converter section of drive, or degrade the capacitor (which can shorten the drive's service life).</li> <li>- Also use a DCR when there are thyristor-driven loads or when power factor correction capacitors are being turned on/off.</li> <li>- Use a DCR when the interphase unbalance ratio of the drive power source exceeds 2%.</li> </ul> $\text{Interphase unbalance (\%)} = \frac{\text{Max. voltage (V)} - \text{Min. voltage (V)}}{\text{3-phase RMS voltage (V)}} \times 67$ <p>2) For supplied power factor correction (harmonic component reduction)</p> <p>Generally a capacitor is used to correct the power factor of the load. However it cannot be used in a system that includes a drive. Using a DCR increases the reactance of the drive's power source so as to decrease harmonic components on the power source lines and correct the drive's power factor. Using a DCR corrects the input power factor to approximately 95%.</p> <p>Note: As shipped, the drive has a jumper bar connected across the terminals P1 and P (+) on the terminal block. Remove the jumper bar when connecting a DCR.</p>
	Output circuit filters (OFLs)	<p>Include an OFL in the drive power output circuit to:</p> <ol style="list-style-type: none"> <li>1) Suppress voltage fluctuation at the motor input terminals This protects the motor from insulation damage caused by the application of high voltage surge currents in 460 V drives.</li> <li>2) Suppress leakage current from the power output lines (due to harmonic components) This reduces the leakage current when the motor is connected by long power feed lines. It is recommended that the length of the power feed line be kept to less than 1200 feet (400 m).</li> <li>3) Minimize emission and/or induction noise in the power feed lines OFLs are effective in reducing noise from long power feed lines, such as those used in plants, etc.</li> </ol> <p>Note: Use an ACR within the allowable carrier frequency range specified by function code F26. The filter will overheat if any other ACR is used.</p>

	<b>Name of option</b>	<b>Function and application</b>
Main option	Ferrite ring reactors for reducing radio frequency noise (ACL)	An ACL is used to reduce radio-frequency noise emitted by the drive. An ACL suppresses the outflow of high frequency harmonics caused by the switching operation in the drive's internal power supply lines. Pass the power supply lines together through the ACL. If wiring length between the drive and motor is less than 66 ft (20 m), place an ACL around the power supply lines; if it is more than 66 ft (20 m), put it in the power output lines of the drive.
	Options for 100 V single-phase power supply	An optional 100 V single-phase power supply may be used to operate a drive designed for a 230 V 3-phase power supply.
Options for Operation and Communications	External potentiometer for frequency command	An external potentiometer may be used to set the drive frequency. Connect the potentiometer to control signal terminals 11 to 13 of the drive.
	Remote keypad	Used when performing drive remote operations with the remote keypad.
	Extension cable for remote operation	The extension cable connects the drive with the remote keypad to enable remote operation of the drive.
	RS485 communications card	For communicating with a PLC or personal computer system.
	Drive support loader software	The Windows-based drive support loader software makes setting function codes easy. Requires use of the RS485 communications card.
Other peripheral equipment	Surge absorbers	A surge absorber suppresses surge currents and noise from the power lines to ensure effective protection of your power system from the malfunctioning of the magnetic contactors, mini-relays and timers.
	Surge suppressor	A surge suppressor absorbs high surge currents induced by lightning, and noise from the power supply lines. Use of a surge suppressor is effective in preventing electronic equipment, including drives, from damage or malfunction from these causes.
	Arresters	An arrester suppresses surge currents and noise from the power supply lines. Use of an arrester is effective in preventing electronic equipment, including drives, from damage or malfunctioning caused by such surges and/or noise.
	Frequency meter	Displays the frequency in accordance with signal output from the drive.
Other options	Mounting adapters	The AF-300 Mini series of drives can be installed in the control board of your system using mounting adapters which use the mounting holes intended for conventional drives (E11 series of 1 hp or below, or 5 hp). The E11S (2 hp/3 hp) and E11 (1 hp/2 hp) series may be replaced with any of the AF-300 Mini series drives without the use of adapters.
	Rail mounting bases	A rail mounting base allows any of the AF-300 Mini series of drive to be mounted on a 35 mm standard DIN rail.

# 10. Compliance with Standards

## 10.1 Compliance with UL Standards and Canadian Standards (cUL certification)

### 10.1.1 General descriptions

Originally, the UL standards were established by Underwriters Laboratories, Inc. as private criteria for inspections/investigations pertaining to fire/accident insurance in the USA. Later, these standards were authorized as the official standards to protect operators, service personnel and the general populace from fires and other accidents in the USA.

cUL certification means that UL has given certification for products to clear CSA Standards. cUL certified products are equivalent to those compliant with CSA Standards.

### 10.1.2 Considerations when using AF-300 Mini in systems to be certified by UL and cUL

If you want to use the AF-300 Mini series of drives as a part of a UL Standards or CSA Standards (cUL certified) certified product, refer to the related notes described on page vii.

## 10.2 Compliance with European Standards

The CE marking on GE Fuji products indicates that they comply with the essential requirements of the Electromagnetic Compatibility (EMC) Directive 89/336/EEC issued by the Council of the European Communities and Low Voltage Directive 73/23/EEC.

Only the EMC filter built-in type of drives that bear a CE marking is compliant with these EMC Directives.

Drives that bear a CE marking or TÜV mark are compliant with the Low Voltage Directive.

### The products comply with the following standards:

Low Voltage Directive	EN50178	1997
EMC Directives	EN61800-3	1996+A11 : 2000
	EN55011	1998+A: 1999
	Immunity	Second environment (EN61800-3+A11 Industrial)
	Emission	Class 1A (EN55011+A1)

(Applicable only to the EMC filter built-in type of drives)

## CAUTION

The AF-300 Mini series of drives are categorized as a "restricted sales distribution class" of the EN61800-3. Therefore, when you use these products with any home appliances or office equipment, you may need to take appropriate countermeasures to reduce or eliminate any noise emitted from these products.

## 10.3 Compliance with EMC Standards

### 10.3.1 Scope

The CE marking on the EMC filter built-in type of drives does not ensure that the entire equipment including our CE-marked products is compliant with the EMC Directive. Therefore, CE marking for the equipment shall be the responsibility of the manufacturer. For this reason, GE Fuji's CE mark is indicated under the condition that the product shall be used within equipment meeting all requirements for the relevant Directives. Implementation of such equipment shall be the responsibility of the manufacturer.

Generally, machinery or equipment may include not only our products but other devices as well. Manufacturers, therefore, shall design the whole system to be compliant with the relevant Directives.

In addition, to satisfy the requirements noted above, use the EMC filter built-in type of drives according to the descriptions contained in this instruction manual. Installing the drive(s) in a metal-shielded control board may be necessary, depending upon the operating environment of the equipment that the drive is to be used with.

### 10.3.2 Recommended installation

To make the machinery or equipment be fully compliant with the EMC Directive, have certified technicians wire the motor and drive in strict accordance with the procedure described below.

Use EMC filter built-in type of drives.

- (1) Mount the EMC grounding flange (that comes with the drive) to the drive with screws in order to ground the wire shield(s). (See Figure 10.1.)

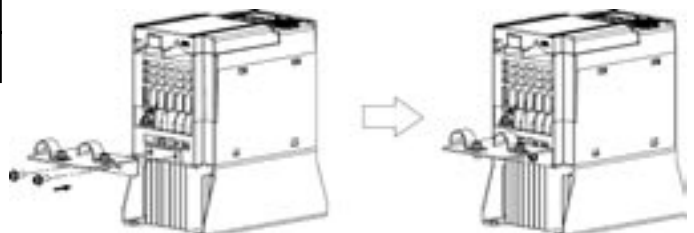

Figure 10.1 Attaching the EMC Grounding Flange

- (2) Use shielded wires for the motor power cable and route it as short as possible. Firmly clamp the wire shield to the flange to ground it. Further, connect the wire shield electrically to the grounding terminal of motor. (See Figure 10.2.)
- (3) Use shielded wires for the control signals of the drive to input to/output from the control terminals. Firmly clamp the control wire shields to the EMC grounding flange (in the same way as the power wires).

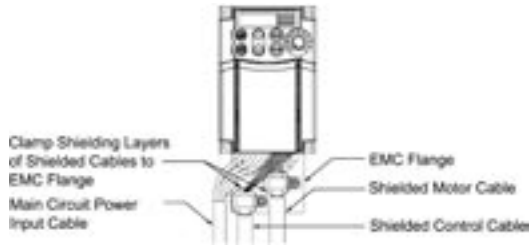

Figure 10.2 Connecting Shielded Cables

- (4) If noise from the drive exceeds the permissible level, enclose the drive and its peripherals within a metal control board as shown in Figure 10.3.

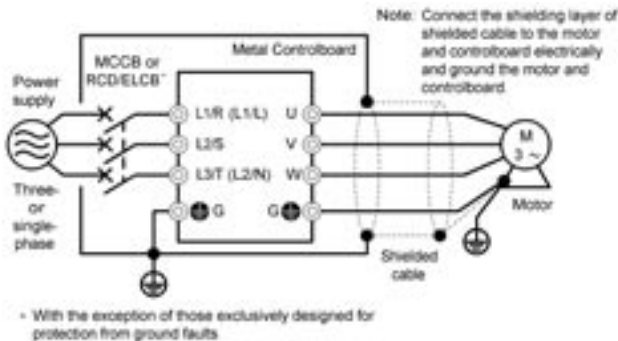

Figure 10.3 Installing the drive into a Controlboard

## 10.4 Harmonic Component Regulation in the EU

### 10.4.1 General comments

When you use general-purpose industrial drives in the EU, the harmonics emitted from the drive to power lines are strictly regulated as stated below.

If a drive whose rated input is 1 kW or less is connected to public low-voltage power supply, it is regulated by the regulation related to harmonics emission from drives to power lines (with the exception of industrial low-voltage power lines). Refer to Figure 10.4 below for details.

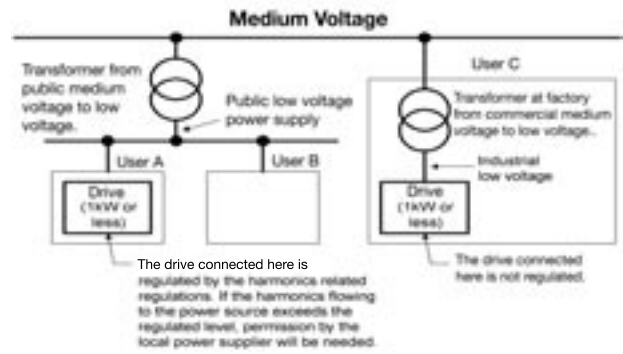

Figure 10.4 Power Source and Regulation

### 10.4.2 Compliance with the harmonic component regulation

Table 11.1 Compliance with Harmonic Component Regulation

Power supply voltage	Drive Hp	w/o DC reactor	w/ DC reactor
3-phase 230 V	1/8	√*	√*
	1/4	√*	√*
	1/2	√*	√*
	1	√*	√*
3-phase 460 V	1/2	—	√
	1	—	√
1-phase 230 V	1/8	—	√
	1/4	—	√
	1/2	—	√
	1	—	—

\* Drive types marked with √ in the table above are compliant with the EN61000-3-2 (+A14), so they may be connected to commercial power lines unconditionally.

Conditions apply when connecting models marked with “—”. If you want to connect them to commercial power lines, you need to obtain permission from the local electric power supplier. In general, you will need to provide the supplier with the harmonics current data of the drive. To obtain the data, contact us.

Note 1) When supplying 3-phase 230 Vac power stepped down from a 3-phase 460 Vac power line using a transformer, the level of harmonic flow from the 460 Vac line will be regulated.

## **10.5 Compliance with the Low Voltage Directive in the EU**

---

### **10.5.1 General comments**

General-purpose drives are regulated by the Low Voltage Directive in the EU. GE Fuji has obtained the proper certification for the Low Voltage Directive from the official inspection agency. GE Fuji states that all our drives with CE and/or TÜV marking are compliant with the Low Voltage Directive.

### **10.5.2 Points for Consideration when using the AF-300 Mini series in a system to be certified by the Low Voltage Directive in the EU**

If you want to use AF-300 Mini series of drives in systems/equipment/appliances in the EU, refer to the cautionary notes on page v.

# ***Notes***

GEH-6647  
030205  
INR-Si47-0817-E



*GE Fuji Drives USA, Inc.  
1501 Roanoke Blvd.  
Suite 435  
Salem, VA 24153*

*[www.GEindustrial.com](http://www.GEindustrial.com)*