

GENERAL DATASHEET VARIABLE SPEED DRIVE

SERIES		MODEL#		
F510		F510-4003-C3-U		
ISSUED		ENCLOSURE/ FRAME		
3/30/2017		NEMA 1 (IP20) / F1		
INPUT AMPS		AC INPUT VOLTAGE	AC INPUT FREQUENCY	AC INPUT PHASE
ND (VT)				
5.9		380-480	50/60	3
OUTPUT HP	OUTPUT AMPS	AC OUTPUT VOLTAGE	AC OUTPUT FREQUENCY	AC OUTPUT PHASE
ND (VT)	ND (VT)			
3	5.4	0-480	0-400	3

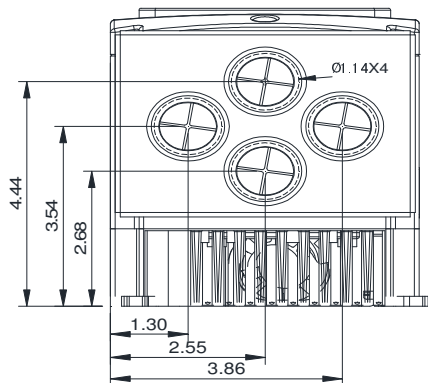
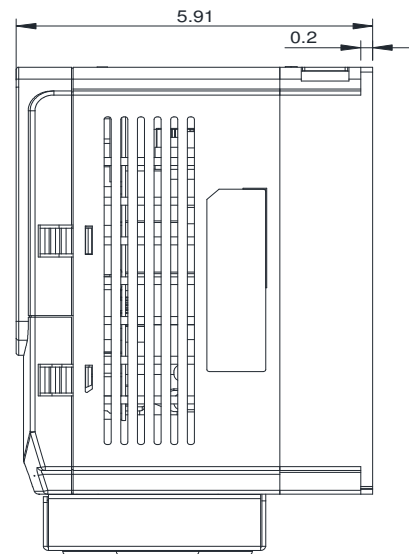
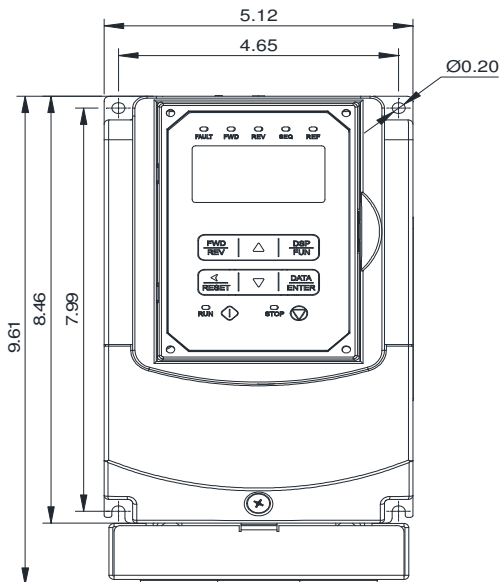

Approved By:	Brian Smith	Drawing No:	F510-460-003-F1	Revision: 0
--------------	-------------	-------------	-----------------	-------------