

## GENERAL DATASHEET VARIABLE SPEED DRIVE

Series <b>E510</b>		MODEL# <b>E510-403-H3-U</b>		
ISSUED <b>8/29/2017</b>		ENCLOSURE/ FRAME <b>NEMA 1 (IP20) / F2</b>		
THREE PHASE INPUT AMPS HD (CT) <b>7.3</b>		AC INPUT VOLTAGE <b>380-480</b>	AC INPUT FREQUENCY <b>50/60</b>	AC INPUT PHASE <b>3</b>
OUTPUT HP HD (CT) <b>3</b>	OUTPUT AMPS HD (CT) <b>5.3</b>	AC OUTPUT VOLTAGE <b>0-480</b>	AC OUTPUT FREQUENCY <b>0-599</b>	AC OUTPUT PHASE <b>3</b>

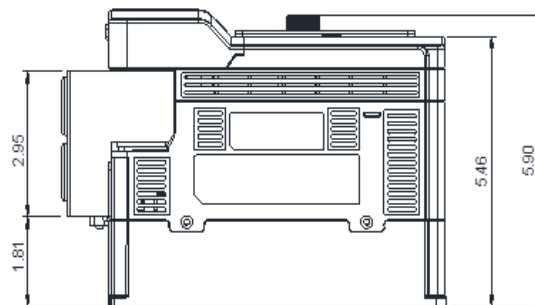
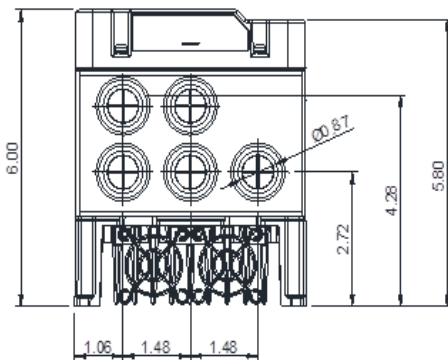
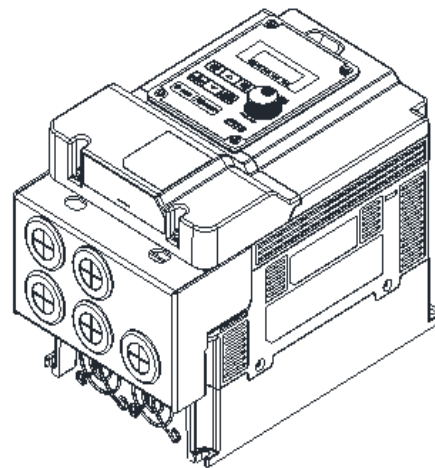
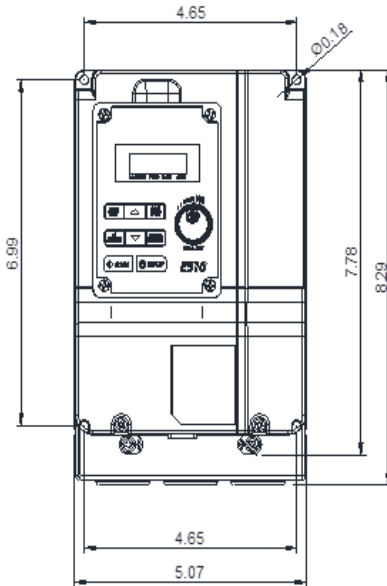

Approved By:	Brian Smith	Drawing No:	E510-460-403-F2	Revision: 0
--------------	-------------	-------------	-----------------	-------------